

# INTERIOR MOULDING & TRIM



METRIE.

THE ART OF FORM





METRIE.

THE ART OF FORM

## WHO WE ARE

Since our beginnings as a small family-owned business in 1926, our dedication to creating high-quality, finely crafted architectural elements has helped us grow to become the largest supplier and manufacturer of solid wood and composite moulding in North America.

[METRIE.COM](http://METRIE.COM)

### DESIGN – PARTNERSHIP – CRAFTSMANSHIP



Our success is driven by a commitment to deliver excellence rooted in design, partnership and craftsmanship.

We believe beauty is in the details, and know that even the smallest of details adds up to create big differences.

Design is in our DNA, and permeates many aspects of our business. Our teams work on everything from trend forecasting to creating new profiles that meet the needs of our customers and homeowners.

We design and craft relationships you can count on – partnerships you can rely on. We collaborate with our partners while listening and talking to designers, architects, builders and contractors – adding value throughout the supply chain.



Our attention to the details helps people create beautiful interior spaces. Spaces to live, work and to truly call home.



FIND US, FOLLOW US, LIKE US & WATCH US!



## MANUFACTURING EXCELLENCE

Metrie operates five domestic manufacturing facilities between the U.S. and Canada. Our solid and finger-jointed wood mills are located close to their respective fiber sources to minimize the costs and environmental impacts of transportation while ensuring that all raw materials are responsibly sourced. Our state-of-the-art MDF mills are technologically advanced and designed for efficient operations, reflecting our customer commitment to delivering finely crafted, high quality products.



## UNMATCHED QUALITY

Our mills allow us the flexibility to provide the right solutions to the markets we serve, understanding regional differences and adhering to strict specification standards. In addition, we have the ability to design, test and produce exclusive profiles to satisfy a custom order or to stay on top of the latest home trends. We have full in-house CAD capabilities and use computer-generated templates to manufacture profiles to extremely tight tolerances. Metrie has built a reputation for setting some of the highest industry standards.



## RESPONSIBLE ACTIONS

With fine craftsmanship comes responsibility, and we are committed to being responsible stewards of forest resources. We strive to maximize the yield from every board using variable width and multiple rip-saws. Our resaws use ultra-thin blades to minimize saw kerf and any products that do not meet our length criteria are manufactured into finger-joint blocks to eventually become finger-jointed mouldings.



TheFinishedSpace.com



Facebook.com/OfficialMetrie



Twitter.com/OfficialMetrie



Instagram.com/OfficialMetrie



LinkedIn.com/Company/Metrie



Pinterest.com/OfficialMetrie



YouTube.com/OfficialMetrie



Houzz.com/pro/Metrie

# TABLE of Contents

- 6 Architraves
- 9 Astragals
- 11 Back Bands
- 12 Baseboards
- 25 Baseboard Caps
- 26 Brick Moulds
- 27 Casings
- 42 Chair Rails
- 43 Corner Guards
- 44 Coves
- 45 Crowns
- 56 Door Stops
- 58 Flat Stock
- 61 Glass & Sash Beads
- 62 Hand Rails
- 63 Jambs
- 65 Lintels
- 66 Panel & Picture Moulds
- 67 Shiplaps
- 68 Squares
- 69 Tongue & Groove Paneling
- 70 Wainscot Caps
- 71 Miscellaneous
- 74 Notes
- 75 Index



## Storage, Handling and Preparation of all Mouldings and S4S Boards

Prior to installation, it is important to acclimate your moulding and trim products by storing them in the installation space for at least 3 days. Wood and wood based products can expand and contract depending on internal and external environmental moisture levels. For best results, be sure to store products in a dry location and transport only if fully protected from water. Keep products clean from dirt and debris and finish according to paint and stain manufacturers' recommendations.



- 1 **ARCHITRAVES:** In classical architecture, it described the main beam resting on the tops of the columns. Today it is often used as a decorative moulding for ornamentation or finishing at the top of windows and doors.
- 2 **BASEBOARDS:** Baseboards are placed along the wall at the floor. They should be chosen to work in harmony with your casings to finish and tie the room together. Baseboards are usually thinner than the casing.
- 3 **BUILD-UPS:** Combining two or more moulding profiles to create a new or custom look. Also called stacking, build-ups make it easy to create the look of custom made trimwork without the high cost.
- 4 **CASINGS:** Casings define the overall character of a room and are often the most visible part of the trim. They are used primarily to cover the gap between drywall and the door or window frame. Casings are generally thicker than the base mouldings.
- 5 **CROWNS:** Crowns are placed along the wall at the ceiling. They come in a wide range of patterns and sizes. Crowns soften the transition from wall to ceiling while adding a distinctive look and charm to your room.
- 6 **FINISH BOARDS:** Finish Boards come in either S4S (Surfaced 4 Sides) or S3S (Surfaced 3 Sides) and are used for a multitude of purposes including shelving, window liner, bases, casing, etc.
- 7 **PANEL MOULDS:** Panel Moulds are used to frame wall paneling and add an accent to your walls. Often used in furniture construction.
- 8 **RAKE MOULD:** Rakes are often used as crowns. In fact, they are sometimes called "solid crowns".
- 9 **WAINSCOT:** Trimwork installed in the area below a chair rail. Numerous options are available including raised panel, shadow box and beaded. Combined with a chair rail and baseboard, Wainscoting creates a dramatic look to any room.
- 10 **WINDOW STOOL:** Also called window sill, a Window Stool is the surface installed below the sash of a window. Trim installed under window stool creates a distinctive look and adds a decorative touch.

# ARCHITRAVES

## ARCHITRAVES

High above windows and doors, architraves work to add grandeur to any space – reducing miter lines and elevating your look. A great architrave is, above all else, the dressing that's built to impress.



Stock Code **MTEK5000**  
(1556499)      Dimensions **1<sup>3</sup>/<sub>16</sub>" x 3<sup>3</sup>/<sub>4</sub>" x 16'**

**COM**

**MH5000**      1<sup>3</sup>/<sub>16</sub>" x 3<sup>3</sup>/<sub>4</sub>" x RL  
(1556159)

**H**

**MFP5000**      1<sup>3</sup>/<sub>16</sub>" x 3<sup>3</sup>/<sub>4</sub>" x 16'  
(1341811)

**MDF/UL**



Stock Code **MAKRB6**  
(1009179)      Dimensions **1<sup>1</sup>/<sub>4</sub>" x 4<sup>3</sup>/<sub>16</sub>" x RL**

**ALD**

## ARCHITRAVES

---



Stock Code  
**1322025**

Dimensions  
**1½" x 5" x 12'**  
**MDF/UL**



Stock Code  
**1328514**  
**1677969**

Dimensions  
**1½" x 5½" x 12'**  
**1½" x 5½" x 16'**  
**MDF/UL**



Stock Code  
**1324430**

Dimensions  
**1½" x 6½" x 12'**  
**MDF/UL**

# ARCHITRAVES

---



Stock Code **MFP5010**  
(1626186) Dimensions **1 3/16" x 4 1/4" x 16'**  
**MDF/UL**

---



Stock Code **MTEK5020**  
(1611393) Dimensions **1 3/16" x 5 1/4" x 16'**  
**COM**

MH5020 (1556160) **1 3/16" x 5 1/4" x RL**  
**H**

MFP5020 (1610429) **1 3/16" x 5 1/4" x RL**  
**MDF/UL**

---



Stock Code **MFP5030**  
(1328518) Dimensions **1 3/16" x 6 1/4" x 16'**  
**MDF/UL**

---



## ASTRAGALS

An astragal is commonly used to seal between a pair of doors. The astragal closes the clearance gap. The vertical moulding attaches to a stile on one of a pair of doors against which the other door strikes or closes.



Stock Code  
**MHAST1315**  
(1002891)

Dimensions  
**1¼" x 2" x 7'**

H

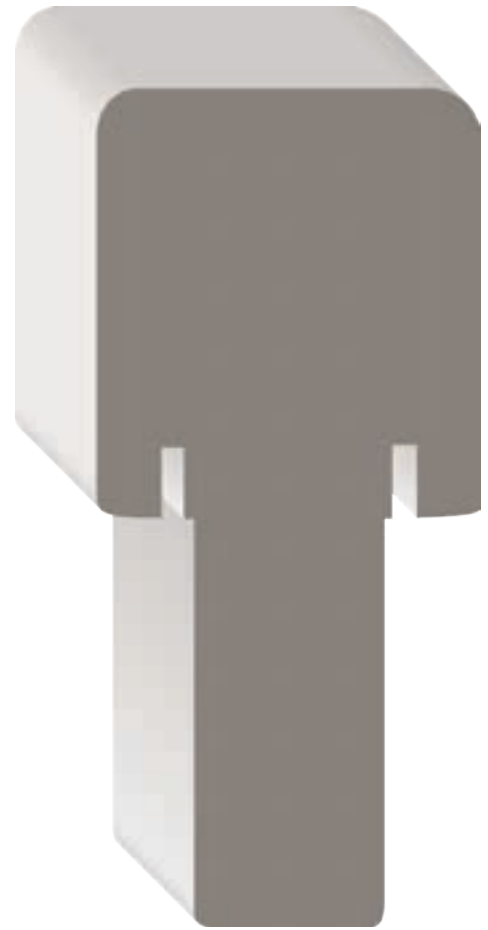

Stock Code  
**MHMP1321**  
(1008570)

Dimensions  
**2" x 4¾" x 99"**

H

# ASTRAGALS

---



Stock Code  
**MHA18**  
(1003139)

Dimensions  
**1 3/16" x 2" x 8'**

**H**

---



Stock Code  
**MPAST130508**  
(1567129)

Dimensions  
**1 1/4" x 2" x 8'**

**PFJ**

---



Stock Code  
**MHA38**  
(1008937)

Dimensions  
**1 3/8" x 3" x 8'**

**MHA47**  
(1002639)

Dimensions  
**1 1/16" x 3" x 7'**

**MHA48**  
(1004654)

Dimensions  
**1 1/16" x 3" x 8'**

**H**

---

## BACK BANDS

Back Bands are used in conjunction with casing or baseboard to create a wide variety of trim options for windows and doors.

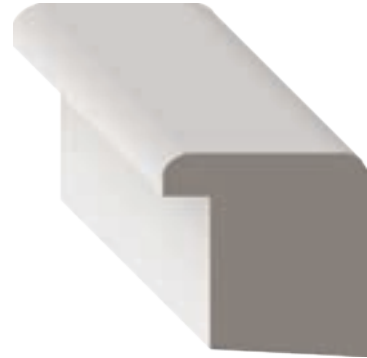

Stock Code  
**MP1021**  
(1588589)

Dimensions  
**1 1/8" x 1 1/8" x 16'**

**PFJ**



Stock Code  
**1544824**

Dimensions  
**1 5/32" x 1 1/2" x 16'**  
**POP**



Stock Code  
**MH00408**  
(1555985)

Dimensions  
**1 1/8" x 1 5/16" x 8'**

**H**

**MP1022**  
(1611064)

**1 1/8" x 1 5/16" x 16'**

**PFJ**



Stock Code  
**MP1029**  
(1611065)

Dimensions  
**1 1/8" x 1 7/8" x 16'**

**PFJ**

# BASEBOARDS

## BASEBOARDS

Your look starts here – at the foundation of a room.

A great baseboard complements a casing and creates a smooth transition from the wall to the floor, guiding you seamlessly from room to room.



Stock Code  
**MP211**  
(1611107)

Dimensions  
 $\frac{7}{16}'' \times 4\frac{3}{16}'' \times 16'$

**PFJ**



Stock Code  
**MH04108**  
(1556001)

Dimensions  
 $\frac{7}{16}'' \times 2\frac{1}{4}'' \times 8'$

**MH04110**  
(1556002)

$\frac{7}{16}'' \times 2\frac{1}{4}'' \times 10'$

**MH04112**  
(1556003)

$\frac{7}{16}'' \times 2\frac{1}{4}'' \times 12'$

**H**



Stock Code  
**MH3102**  
(1556073)

Dimensions  
 $1\frac{3}{32}'' \times 3\frac{1}{4}'' \times \text{RL}$

**MH310208**  
(1556074)

$1\frac{3}{32}'' \times 3\frac{1}{4}'' \times 8'$

**MH310210**  
(1556075)

$1\frac{3}{32}'' \times 3\frac{1}{4}'' \times 10'$

**MH310212**  
(1556076)

$1\frac{3}{32}'' \times 3\frac{1}{4}'' \times 12'$

**H**



Stock Code  
**MP290**  
(1611113)

Dimensions  
 $\frac{1}{2}'' \times 3\frac{3}{16}'' \times 16'$

**PFJ**

# BASEBOARDS



Stock Code  
**MP444**  
(1556318)

Dimensions  
 **$\frac{7}{16}'' \times 3\frac{3}{16}'' \times 15'$**

**PFJ**



Stock Code  
**MFP444U**  
(1555905)

Dimensions  
 **$\frac{9}{16}'' \times 3\frac{1}{8}'' \times 16'$**

**MDF/UL**



Stock Code  
**MFP3140**  
(1328267)

Dimensions  
 **$\frac{3}{8}'' \times 3\frac{1}{4}'' \times 14'$**

**MDF/UL**



Stock Code  
**MFP8312**  
(1555941)

Dimensions  
 **$\frac{1}{2}'' \times 4\frac{1}{4}'' \times 16'$**

**MDF/UL**

# BASEBOARDS



Stock Code  
**MTEK625**  
(1556503)

Dimensions  
**1/2" x 2 1/4" x 16'**

**COM**

- MH625 (1556173) 7/16" x 2 1/4" x RL
- MH62508 (1556174) 7/16" x 2 1/4" x 8'
- MH62510 (1556175) 7/16" x 2 1/4" x 10'
- MH62512 (1556176) 7/16" x 2 1/4" x 12'

**H**

MFP625 (1555931) 1/2" x 2 1/4" x 16'

**MDF/UL**

MP625 (1328825) 3/8" x 2 1/4" x 16'

**PFJ**



Stock Code  
**MECH624**  
(1610139)

Dimensions  
**5/16" x 2 3/4" x 14'**

**PEH**



Stock Code  
**MH621**  
(1009329)

Dimensions  
**1/2" x 4 1/4" x RL**

**H**



Stock Code  
**MAK623**  
(1006737)

Dimensions  
**9/16" x 3 1/4" x RL**

**ALD**

MTEK623 (1011022) 1/2" x 3 1/4" x 16'

MTEK62307 (1006843) 1/2" x 3 1/4" x 7'

**COM**

MFVG623 (1555968) 1 3/32" x 3 1/4" x RL

**FIR**

MH623 (1626374) 7/16" x 3 1/4" x RL

MH62308 (1556170) 7/16" x 3 1/4" x 8'

MH62310 (1556171) 7/16" x 3 1/4" x 10'

MH62312 (1556172) 7/16" x 3 1/4" x 12'

**H**

MFP623 (1566985) 1/2" x 3 1/4" x 16'

MFP62312 (1555930) 1/2" x 3 1/4" x 12'

**MDF/UL**

MR0623 (1556440) 3/8" x 3 1/4" x RL

**O**

MP623 (1328824) 3/8" x 3 1/4" x 16'

MP280 (1611112) 1/2" x 3 1/4" x 16'

**PFJ**

# BASEBOARDS



Stock Code  
**MAK618**  
(1008069)

Dimensions  
**1/2" x 5 1/4" x RL**

**ALD**

**MTEK618**  
(1556501)

**1/2" x 5 1/4" x 16'**

**COM**

**MH618**  
(1556168)

**1/2" x 5 1/4" x RL**

**H**

**MFP618**  
(1328523)

**1/2" x 5 1/4" x 16'**

**MDF/UL**

**MP618**  
(1556324)

**3/16" x 5 3/16" x 16'**

**PFJ**



Stock Code  
**MFP624**  
(1610440)

Dimensions  
**1/2" x 4 1/4" - 16'**

**MDF/UL**



Stock Code  
**MFP635**  
(1555933)

Dimensions  
**3/16" x 5 5/8" x 16'**

**MDF/UL**



Stock Code  
**MFP414U**  
(1566948)

Dimensions  
**3/16" x 5 1/4" x 16'**

**MDF/UL**

# BASEBOARDS



Stock Code  
**MFP8910**  
(1341835)

Dimensions  
 **$\frac{3}{8}$ " x  $3\frac{3}{8}$ " x 16'**

**MDF/UL**



Stock Code  
**MFP094**  
(1555833)

Dimensions  
 **$\frac{7}{16}$ " x 4" x 16'**

**MDF/UL**



Stock Code  
**MFP310**  
(1555882)

Dimensions  
 **$\frac{1}{2}$ " x  $4\frac{1}{8}$ " x 16'**

**MDF/UL**



Stock Code  
**MH412U**  
(1556144)

Dimensions  
 **$\frac{7}{16}$ " x  $4\frac{1}{4}$ " x RL**

**H**

**MFP412U**  
(1328503)

**$\frac{7}{16}$ " x  $4\frac{1}{4}$ " x 16'**

**MDF/UL**



# BASEBOARDS



Stock Code  
**MP653**  
(1328826)

Dimensions  
 **$\frac{3}{8}$ " x  $3\frac{1}{4}$ " x 16'**

**PFJ**



Stock Code  
**MP663**  
(1328829)

Dimensions  
 **$\frac{1}{2}$ " x  $4\frac{3}{16}$ " x 16'**

**PFJ**



Stock Code  
**MFP095**  
(1064044)

Dimensions  
 **$\frac{5}{16}$ " x 5" x 16'**

**MDF/UL**



Stock Code  
**MFP206**  
(1509989)

Dimensions  
 **$\frac{9}{16}$ " x  $5\frac{1}{4}$ " x 16'**

**MDF/UL**

# BASEBOARDS

---



Stock Code  
**MFP8243**  
(1555939)

Dimensions  
**1/2" x 4 1/4" x 16'**

**MDF/UL**



Stock Code  
**MFP8234**  
(1555938)

Dimensions  
**3/16" x 5 1/2" x 16'**

**MDF/UL**



Stock Code  
**MFP161**  
(1555868)

Dimensions  
**3/16" x 5 1/4" x 16'**

**MDF/UL**



Stock Code  
**MFP163**  
(1555869)

Dimensions  
**3/16" x 7 1/4" x 16'**

**MDF/UL**

# BASEBOARDS



Stock Code  
**MFP207**  
(1002010)

Dimensions  
 **$\frac{1}{16}$ " x 7 $\frac{1}{4}$ " x 16'**  
**MDF/UL**



Stock Code  
**1566981**

Dimensions  
 **$\frac{1}{16}$ " x 5 $\frac{3}{4}$ " x 16'**  
**MDF/UL**



Stock Code  
**MP673**  
(1328830)

Dimensions  
 **$\frac{1}{16}$ " x 5 $\frac{1}{8}$ " x 16'**  
**PFJ**



Stock Code  
**MH545**  
(1556166)

Dimensions  
 **$\frac{1}{16}$ " x 5" x RL**  
**H**

**1328399**  
**MFP545**  
(1341818)

**$\frac{5}{8}$ " x 5" x 14'**  
 **$\frac{1}{16}$ " x 5" x 16'**  
**MDF/UL**

# BASEBOARDS



Stock Code  
**MAK3111**  
 (1010058)  
**MAK3112**  
 (1555678)

Dimensions  
 1/2" x 3 1/4" x RL  
 1/2" x 3 1/2" x RL

**ALD**

**MFVG3112**  
 (1002782)

1/2" x 3 1/4" x RL

**FIR**

**MH3112**  
 (1556077)

3/8" x 3 1/4" x RL

**H**

**MFP3112**  
 (1009326)

1/2" x 3 1/4" x 16'

**MDF/UL**

**MP3112**  
 (1556300)

3/8" x 3 3/16" x 16'

**PFJ**



Stock Code  
**MAUF573**  
 (1610088)

Dimensions  
 1 1/32" x 3 1/4" x RL

**MAF**

**MACH573**  
 (1609941)

3/8" x 3 1/4" x 14'

**MPH**

**MASC573**  
 (1610046)

3/8" x 3 1/4" x 14'

**PCH**



Stock Code  
**MH469**  
 (1006585)

Dimensions  
 1/2" x 3 1/2" x RL

**H**

# BASEBOARDS



Stock Code

**MAK585B0**  
(1050670)

**MAK585B010**  
(1681611)

Dimensions

$\frac{5}{8}$ " x 5" x RL

$\frac{5}{8}$ " x 5" x 10'

**ALD**



Stock Code

**MFSP514**  
(1380952)

Dimensions

$\frac{1}{2}$ " x  $5\frac{1}{4}$ " x 16'

**MDF/UL**



Stock Code

**MAK603**  
(1009884)

Dimensions

$\frac{5}{8}$ " x  $5\frac{1}{4}$ " x RL

**ALD**



Stock Code

**MH569**  
(1008980)

**MH669**  
(1009273)

Dimensions

$\frac{1}{2}$ " x  $4\frac{1}{2}$ " x RL

$\frac{7}{16}$ " x  $5\frac{1}{2}$ " x RL

**H**

# BASEBOARDS

---



Stock Code  
**1324433**

Dimensions  
**3/4" x 5 1/2" x 16'**  
MDF/UL



Stock Code  
**1324436**

Dimensions  
**3/4" x 7 1/4" x 16'**  
MDF/UL



Stock Code  
**1318199**

Dimensions  
**3/4" x 5 1/2" x 16'**  
MDF/UL



Stock Code  
**1318202**

Dimensions  
**3/4" x 7 1/4" x 16'**  
MDF/UL

# BASEBOARDS



Stock Code  
**MH751**  
(1003931)

Dimensions  
**5/8" x 7 1/4" x RL**

**H**



Stock Code  
**1318184**

Dimensions  
**5/8" x 5 1/2" x 16'**  
**MDF/UL**



Stock Code  
**MH750**  
(1004178)

Dimensions  
**5/8" x 5 1/4" x RL**

**H**



Stock Code  
**MFP029**  
(1555822)

Dimensions  
**9/16" x 5 1/4" x 16'**

**MDF/UL**

# BASEBOARDS

---



Stock Code  
**1677449**

Dimensions  
**1/2" x 5" x 16'**  
MDF/UL



Stock Code  
**1328537**  
**1626223**

Dimensions  
**1/2" x 6" x 14'**  
**1/2" x 6" x 16'**  
MDF/UL



Stock Code  
**1323953**

Dimensions  
**3/16" x 4 1/2" x 16'**  
MDF/UL

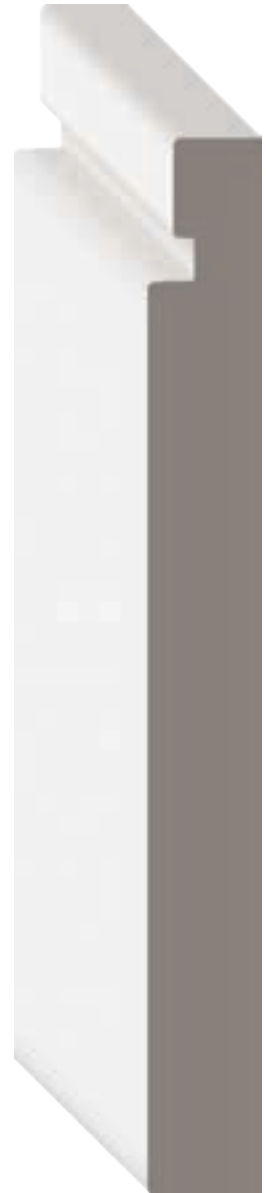

Stock Code  
**1323956**

Dimensions  
**3/16" x 5 1/2" x 16'**  
MDF/UL



## BASEBOARD CAPS

Baseboard caps are added to the top of regular baseboard moulding and flush to the wall to create a finished and more complex architectural moulding.



Stock Code  
**MP275**  
(1611111)

Dimensions  
 $\frac{5}{8}'' \times 1\frac{1}{16}'' \times 16'$

**PFJ**



Stock Code  
**MH165**  
(1556023)

Dimensions  
 $\frac{3}{4}'' \times 1\frac{1}{8}'' \times RL$

**H**

**MP165**  
(1611093)

Dimensions  
 $\frac{3}{4}'' \times 1\frac{1}{8}'' \times RL$

**PFJ**



Stock Code  
**MP502**  
(1611148)

Dimensions  
 $\frac{5}{8}'' \times 1\frac{1}{2}'' \times 16'$

**PFJ**

# BRICK MOULDS

## BRICK MOULDS

A brick mould is mainly used as exterior casing around doors. The most common size is 2"; however, 1 1/2" and 1 1/4" sizes are available. Brick moulds can also be used in place of a crown and as a transition under window sills.



Stock Code  
**MH50708**  
(1610792)  
**MH50712**  
(1556163)

Dimensions  
**1 3/16" x 1 1/2" x 8'**  
**1 3/16" x 1 1/2" x 12'**

**H**



Stock Code  
**MP6921**  
(1611166)

Dimensions  
**1 1/4" x 2 1/4" x 18'**

**PFJ**



Stock Code  
**MFVG180**  
(1626279)

Dimensions  
**1 3/16" x 1 5/16" x RL**

**FIR**

**MH180**  
(1556025)

Dimensions  
**1 3/16" x 1 5/16" x RL**

**MH18007**  
(1556026)

Dimensions  
**1 3/16" x 1 5/16" x 7'**

**H**

**MP180**  
(1556281)

Dimensions  
**1 3/16" x 1 5/16" x 14'**

**MP18007**  
(1556282)

Dimensions  
**1 3/16" x 1 5/16" x 7'**

**MP18018**  
(1328752)

Dimensions  
**1 3/16" x 1 5/16" x 18'**

**MP180MIT8215**  
(1556285)

Dimensions  
**1 3/16" x 1 5/16" x 82 1/4"**

**PFJ**

# CASINGS

Casings bring a room together – left to right, top to bottom. And like any framing element, the options are endless, from build-ups of multiple pieces to full wraps. With casings, there's no wrong way, only your way.



Stock Code  
**MH301408**  
(1556070)

Dimensions  
**7/16" x 2 3/16" x 8'**

**H**



Stock Code  
**MP327**  
(1567148)

Dimensions  
**1 1/16" x 2 1/4" x 14'**

**PFJ**



Stock Code  
**MH300007**  
(1328591)

Dimensions  
**1/2" x 1 1/2" x 7'**

**MH300008**  
(1556057) **1/2" x 1 1/2" x 8'**

**MH300010**  
(1556058) **1/2" x 1 1/2" x 10'**

**MH300012**  
(1556059) **1/2" x 1 1/2" x 12'**

**H**

**MFP300007**  
(1555878) **1/2" x 1 5/8" x 7'**

**MFP3000**  
(1555877) **1/2" x 1 5/8" x 16'**

**MDF/UL**

**MEAON3000**  
(1555721) **7/16" x 1 7/16" x 14'**

**PAO**

**MEGON3000**  
(1555741) **7/16" x 1 7/16" x 14'**

**P60**



Stock Code  
**MH3002**  
(1556060) **1/2" x 2 3/16" X RL**

**MH300207**  
(1610661) **1/2" x 2 3/16" x 7'**

**MH300208**  
(1556062) **1/2" x 2 3/16" x 8'**

**MH300210**  
(1610663) **1/2" x 2 3/16" x 10'**

**MH300212**  
(1556064) **1/2" x 2 3/16" x 12'**

**H**

**MFP3002**  
(1050329) **9/16" x 2 1/4" x 16'**

**MFP300207**  
(1555880) **9/16" x 2 1/4" x 7'**

**MDF/UL**

**MRO3002**  
(1328875) **7/16" x 2 1/4" X RL**

**O**

**MEAON3002**  
(1006192) **7/16" x 2 1/4" x 14'**

**PAO**

**MEGON3002**  
(1002393) **7/16" x 2 1/4" x 14'**

**P60**

# CASINGS



Stock Code  
**MP256**  
(1556297)

Dimensions  
**5/8" x 1 5/8" x 14'**

**PFJ**



Stock Code  
**MH258**  
(1556036)

Dimensions  
**1 1/16" x 2 3/16" x RL**

**MH25807**  
(1556037)

**1 1/16" x 2 3/16" x 7'**

**H**



Stock Code  
**MH005**  
(1610561)

Dimensions  
**3/4" x 3 7/16" x RL**

**MH00508**  
(1555986)

**3/4" x 3 7/16" x 8'**

**H**



Stock Code  
**MFP3122**  
(1555886)

Dimensions  
**1" x 3 1/2" x 16'**

**MDF/UL**



Stock Code Dimensions  
**MH300507**  $\frac{1}{2}'' \times 1\frac{1}{2}'' \times 7'$   
 (1556065)  
**MH300510**  $\frac{1}{2}'' \times 1\frac{1}{2}'' \times 10'$   
 (1556067)

**H**

**MP3005**  $\frac{1}{2}'' \times 1\frac{1}{2}'' \times 14'$   
 (1328764)

**PFJ**



Stock Code Dimensions  
**MTEK356**  $\frac{3}{16}'' \times 2\frac{1}{4}'' \times 16'$   
 (1556496)  
**MTEK35607**  $\frac{3}{16}'' \times 2\frac{1}{4}'' \times 7'$   
 (1556497)  
**1681178**  $\frac{3}{16}'' \times 2\frac{1}{4}'' \times 81\frac{1}{4}''$   
**COM**

**MFP356**  $\frac{3}{16}'' \times 2\frac{1}{4}'' \times 16'$   
 (1555892)  
**MFP35610**  $\frac{3}{16}'' \times 2\frac{1}{4}'' \times 10'$   
 (1555893)  
**MFP35617**  $\frac{3}{16}'' \times 2\frac{1}{4}'' \times 17'$   
 (1555894)  
**MFP35685**  $\frac{3}{16}'' \times 2\frac{1}{4}'' \times 85''$   
 (1555895)  
**1681176**  $\frac{3}{16}'' \times 2\frac{1}{4}'' \times 81\frac{1}{4}''$   
**MDF/UL**



Stock Code Dimensions  
**MH125**  $\frac{3}{16}'' \times 2\frac{1}{16}'' \times 14'$   
 (1556021)  
**MH12507**  $\frac{3}{16}'' \times 2\frac{1}{16}'' \times 7'$   
 (1556022)

**H**



Stock Code Dimensions  
**MAK356WM**  $\frac{3}{4}'' \times 2\frac{1}{4}'' \times 14'$   
 (1050667)

**ALD**

**MFVG356WM07**  $\frac{5}{8}'' \times 2\frac{1}{4}'' \times 7'$   
 (1555962)

**FIR**

**MH356**  $\frac{5}{8}'' \times 2\frac{1}{4}'' \times 14'$   
 (1556134)

**MH35607**  $\frac{5}{8}'' \times 2\frac{1}{4}'' \times 7'$   
 (1556135)

**MH35608**  $\frac{5}{8}'' \times 2\frac{1}{4}'' \times 8'$   
 (1556136)

**MH35610**  $\frac{5}{8}'' \times 2\frac{1}{4}'' \times 10'$   
 (1556137)

**MH35612**  $\frac{5}{8}'' \times 2\frac{1}{4}'' \times 12'$   
 (1556138)

**H**

**MEUF356**  $\frac{7}{16}'' \times 2\frac{7}{32}'' \times 14'$   
 (1610265)

**MUF**

**MRO356**  $\frac{7}{16}'' \times 2\frac{1}{16}'' \times 14'$   
 (1006931)

**O**

Stock Code Dimensions  
**MEAON356**  $\frac{7}{16}'' \times 2\frac{7}{32}'' \times 14'$   
 (1555723)

**PAO**

**MESC356**  $\frac{7}{16}'' \times 2\frac{7}{32}'' \times 14'$   
 (1555777)

**PCH**

**MEDO356**  $\frac{7}{16}'' \times 2\frac{7}{32}'' \times 14'$   
 (1555733)

**PDO**

**MECH356**  $\frac{7}{16}'' \times 2\frac{7}{32}'' \times 14'$   
 (1610135)

**PEH**

**MESAN356**  $\frac{7}{16}'' \times 2\frac{7}{32}'' \times 14'$   
 (1610198)

**PEA**

**MESM356**  $\frac{7}{16}'' \times 2\frac{7}{32}'' \times 14'$   
 (1007805)

**PEM**

**MP356WM**  $\frac{5}{8}'' \times 2\frac{1}{4}'' \times 14'$   
 (1394452)

**MP356WM07**  $\frac{5}{8}'' \times 2\frac{1}{4}'' \times 7'$   
 (1382747)

**PFJ**

**MEGON356**  $\frac{7}{16}'' \times 2\frac{7}{32}'' \times 14'$   
 (1008298)

**PGO**

# CASINGS



Stock Code  
**MH410U**  
 (1556140)  
**MH410U07**  
 (1556141)

Dimensions  
 $1\frac{1}{16}'' \times 2\frac{1}{4}'' \times \text{RL}$   
 $1\frac{1}{16}'' \times 2\frac{1}{4}'' \times 7'$

**H**

-----  
**MFP410U**  
 (1566938)  
**MDF/UL**



Stock Code  
**MH1208**  
 (1328587)  
**MH120807**  
 (1556017)

Dimensions  
 $1\frac{1}{16}'' \times 2\frac{1}{2}'' \times \text{RL}$   
 $1\frac{1}{16}'' \times 2\frac{1}{2}'' \times 7'$

**H**

-----  
**MP1208**  
 (1328748)  
**PFJ**



Stock Code  
**MH3211**  
 (1002120)

Dimensions  
 $\frac{5}{8}'' \times 2\frac{1}{4}'' \times \text{RL}$

**H**

-----  
**MP190**  
 (1611102)  
**PFJ**



Stock Code  
**MFP092**  
 (1555830)  
**MFP09207**  
 (1555831)

Dimensions  
 $\frac{5}{8}'' \times 2\frac{1}{2}'' \times 16'$   
 $\frac{5}{8}'' \times 2\frac{1}{2}'' \times 7'$

**MDF/UL**



Stock Code  
**MFP350**  
(1555891)

Dimensions  
 **$\frac{3}{16}$ " x 2 $\frac{1}{4}$ " x 16'**

**MDF/UL**



Stock Code  
**MH156**  
(1011098)  
**MH15607DS**  
(1005414)

Dimensions  
 **$\frac{3}{16}$ " x 2 $\frac{1}{4}$ " x RL**  
 **$\frac{3}{16}$ " x 2 $\frac{1}{4}$ " x 7'**

**H**



Stock Code  
**MH4443D**  
(1556147)  
**MH4443D08**  
(1556148)  
**MH4443D12**  
(1556150)

Dimensions  
 **$\frac{3}{16}$ " x 3 $\frac{1}{8}$ " x RL**  
 **$\frac{3}{16}$ " x 3 $\frac{1}{8}$ " x 8'**  
 **$\frac{3}{16}$ " x 3 $\frac{1}{8}$ " x 12'**

**H**



Stock Code  
**MP113**  
(1611087)

Dimensions  
 **$\frac{5}{8}$ " x 3 $\frac{1}{4}$ " x 16'**

**PFJ**

# CASINGS



Stock Code  
**MFP346**  
(1566915)

Dimensions  
 $\frac{3}{16}$ " x  $2\frac{1}{4}$ " x 17'

**MDF/UL**



Stock Code  
**MH411U**  
(1626369)

Dimensions  
 $1\frac{1}{16}$ " x 3" x RL

**MH411U08**  
(1009060)

$1\frac{1}{16}$ " x 3" x 8'

**H**

**MFP411U**  
(1626154)

$1\frac{1}{16}$ " x 3" x 15'

**MDF/UL**



Stock Code  
**MFP093**  
(1555832)

Dimensions  
 $\frac{5}{8}$ " x  $3\frac{1}{4}$ " x 16'

**MDF/UL**



Stock Code  
**MFP8063**  
(1448090)

Dimensions  
 $1\frac{1}{16}$ " x  $3\frac{1}{4}$ " x 16'

**MDF/UL**





Stock Code  
**MH033**  
(1555997)

Dimensions  
 **$\frac{5}{8}$ " x  $2\frac{3}{16}$ " x RL**

**H**



Stock Code  
**MH019**  
(1555991)

Dimensions  
 **$\frac{9}{16}$ " x  $2\frac{1}{4}$ " x RL**

**MH01907**  
(1555992)

**$\frac{9}{16}$ " x  $2\frac{1}{4}$ " x 7'**

**MH01910**  
(1555994)

**$\frac{9}{16}$ " x  $2\frac{1}{4}$ " x 10'**

**H**

**MFP019**  
(1555820)

**$\frac{9}{16}$ " x  $2\frac{1}{4}$ " x 16'**

**MFP01907**  
(1555821)

**$\frac{9}{16}$ " x  $2\frac{1}{4}$ " x 7'**

**MDF/UL**



Stock Code  
**MP140**  
(1611091)

Dimensions  
 **$1\frac{9}{32}$ " x  $2\frac{15}{32}$ " x 14'**

**PFJ**



Stock Code  
**MFP8233**  
(1046142)

Dimensions  
 **$\frac{9}{16}$ " x  $3\frac{3}{4}$ " x 16'**

**MDF/UL**

# CASINGS



Stock Code **MTEK003**  
(1556485)

Dimensions  
**1<sup>1</sup>/<sub>16</sub>" x 3<sup>3</sup>/<sub>4</sub>" x 16'**

**COM**

**MH003**  
(1626324)

Dimensions  
**5<sup>5</sup>/<sub>8</sub>" x 3<sup>3</sup>/<sub>4</sub>" x RL**

**MH00308**  
(1555984)

Dimensions  
**5<sup>5</sup>/<sub>8</sub>" x 3<sup>3</sup>/<sub>4</sub>" x 8'**

**H**

**MFP003**  
(1555819)

Dimensions  
**1<sup>1</sup>/<sub>16</sub>" x 3<sup>3</sup>/<sub>4</sub>" x 16'**

**MDF/UL**



Stock Code **MP150**  
(1611092)

Dimensions  
**5<sup>5</sup>/<sub>8</sub>" x 3<sup>3</sup>/<sub>4</sub>" x 16'**

**PFJ**



Stock Code **MH535**  
(1556164)

Dimensions  
**1<sup>1</sup>/<sub>16</sub>" x 3<sup>1</sup>/<sub>2</sub>" x RL**

**MH53508**  
(1556165)

Dimensions  
**1<sup>1</sup>/<sub>16</sub>" x 3<sup>1</sup>/<sub>2</sub>" x 8'**

**H**

**MFP535**  
(1610431)

Dimensions  
**1<sup>1</sup>/<sub>16</sub>" x 3<sup>1</sup>/<sub>2</sub>" x 16'**

**MDF/UL**



Stock Code **MH215**  
(1556031)

Dimensions  
**5<sup>5</sup>/<sub>8</sub>" x 3<sup>3</sup>/<sub>16</sub>" x RL**

**H**



Stock Code  
**1675150**

Dimensions  
**1" x 3½" x 16'**  
MDF/UL



Stock Code  
**MH001**  
(1555978)

Dimensions  
**7/16" x 2¾" x RL**

Stock Code  
**MH00107**  
(1555979)

Dimensions  
**7/16" x 2¾" x 7'**

Stock Code  
**MH00108**  
(1328584)

Dimensions  
**7/16" x 2¾" x 8'**

Stock Code  
**MH00110**  
(1555981)

Dimensions  
**7/16" x 2¾" x 10'**

H



Stock Code  
**MH493**  
(1007076)

Dimensions  
**½" x 2¼" x RL**

Stock Code  
**MH49307**  
(1008483)

Dimensions  
**½" x 2¼" x 7'**

H



Stock Code  
**MFIG472**  
(1010019)

Dimensions  
**5/8" x 2½" x RL**

Stock Code  
**MFIG47207**  
(1555964)

Dimensions  
**5/8" x 2½" x 7'**

FIR

Stock Code  
**MH472**  
(1556152)

Dimensions  
**5/8" x 2½" x RL**

Stock Code  
**MH47207**  
(1610775)

Dimensions  
**5/8" x 2½" x 7'**

Stock Code  
**MH47207-VEN**  
(1610776)

Dimensions  
**11/16" x 2½" x 7'**

H

Stock Code  
**MFP472**  
(1328373)

Dimensions  
**9/16" x 2½" x 14'**

Stock Code  
**MFP492**  
(1555909)

Dimensions  
**½" x 2½" x 14'**

Stock Code  
**MFP494**  
(1555910)

Dimensions  
**½" x 3¼" x 16'**

Stock Code  
**MFP49408**  
(1566956)

Dimensions  
**½" x 3¼" x 8'**

Stock Code  
**MFSP472**  
(1328569)

Dimensions  
**9/16" x 2½" x 16'**

Stock Code  
**MFSP492**  
(1050402)

Dimensions  
**½" x 2½" x 16'**

Stock Code  
**MFSP494**  
(1050405)

Dimensions  
**½" x 3¼" x 16'**

MDF/UL

# CASINGS



Stock Code  
**MH01007**  
(1555987)  
**MH01008**  
(1328586)  
**MH01010**  
(1555989)  
**MH01012**  
(1555990)

Dimensions  
**7/16" x 1 1/2" x 7'**  
**7/16" x 1 1/2" x 8'**  
**7/16" x 1 1/2" x 10'**  
**7/16" x 1 1/2" x 12'**

**H**



Stock Code  
**MTEK473**  
(1588769)

Dimensions  
**9/16" x 2 1/4" x 16'**

**COM**

**MFVG473**  
(1555965)

Dimensions  
**5/8" x 2 3/32" x RL**

**FIR**

**MFP473**  
(1555907)

Dimensions  
**9/16" x 2 1/4" x 16'**

**MFP47307**  
(1555908)

Dimensions  
**9/16" x 2 1/4" x 7'**

**MDF/UL**

**MACH473**  
(1609939)

Dimensions  
**1/2" x 2 1/4" x 14'**

**MPH**

**MAUF473**  
(1610086)

Dimensions  
**1/2" x 2 1/4" x 14'**

**MUF**

**MASC473**  
(1011389)

Dimensions  
**1/2" x 2 1/4" x 14'**

**PCH**



Stock Code  
**MAK103BO**  
(1555675)

Dimensions  
**3/4" x 2 1/2" x RL**

**MAK103B008**  
(1668157)

Dimensions  
**3/4" x 2 1/2" x 8'**

**ALD**

**MFP10385BO**  
(1610320)

Dimensions  
**1 1/16" x 2 1/2" x 85"**

**MDF/UL**

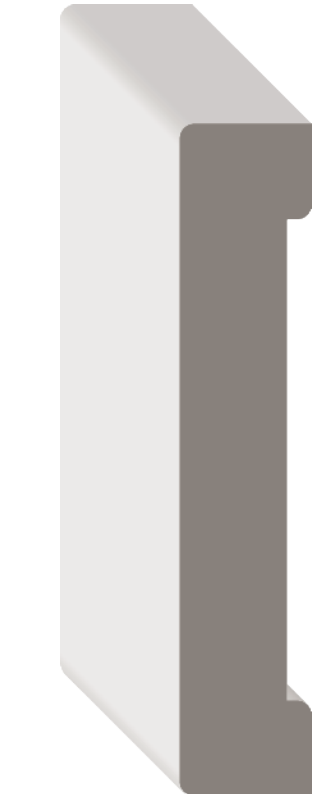

Stock Code  
**1670311**

Dimensions  
**1 1/16" x 3 1/2" x 16'**

**PFJ**



Stock Code	Dimensions
<b>MFVG338</b> (1555958)	$\frac{3}{4}$ " x $3\frac{1}{2}$ " x RL
<b>MFVG33807</b> (1555959)	$\frac{3}{4}$ " x $3\frac{1}{2}$ " x 7'
<b>MFVG33808</b> (1555960)	$\frac{3}{4}$ " x $3\frac{1}{2}$ " x 8'

**FIR**



Stock Code	Dimensions
<b>MAK104BO</b> (1555676)	$\frac{3}{4}$ " x $3\frac{1}{2}$ " x RL
<b>MAK104B008</b> (1050664)	$\frac{3}{4}$ " x $3\frac{1}{2}$ " x 8'

**ALD**

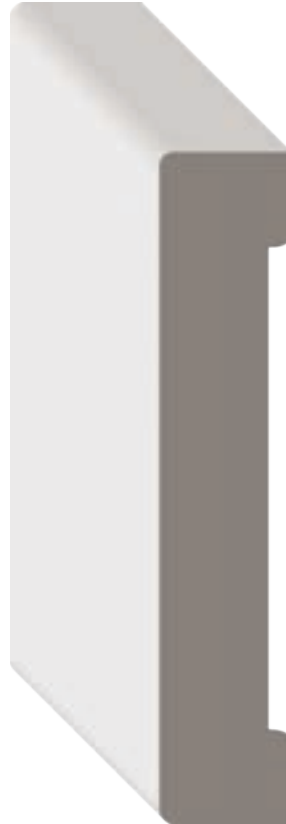

Stock Code	Dimensions
<b>MTEK495</b> (1556498)	$1\frac{1}{16}$ " x $3\frac{1}{2}$ " x 16'

**COM**

<b>MH495</b> (1556156)	$\frac{5}{8}$ " x $3\frac{1}{2}$ " x RL
<b>MH49507</b> (1556157)	$\frac{5}{8}$ " x $3\frac{1}{2}$ " x 7'
<b>MH49508</b> (1556158)	$\frac{5}{8}$ " x $3\frac{1}{2}$ " x 8'
<b>MH49507-VEN</b> (1005003)	$1\frac{1}{16}$ " x $3\frac{1}{2}$ " x 7'
<b>MH49508-VEN</b> (1610785)	$1\frac{1}{16}$ " x $3\frac{1}{2}$ " x 8'

**H**

<b>MFP495</b> (1555911)	$1\frac{1}{16}$ " x $3\frac{1}{2}$ " x 16'
<b>MFP49507</b> (1545341)	$1\frac{1}{16}$ " x $3\frac{1}{2}$ " x 7'

**MDF/UL**



Stock Code	Dimensions
<b>MAK413</b> (1007674)	$\frac{3}{4}$ " x $3\frac{1}{4}$ " x RL
<b>MAK41308</b> (1009582)	$\frac{3}{4}$ " x $3\frac{1}{4}$ " x 8'

**ALD**

# CASINGS

---



Stock Code  
**1675700**  
**1675702**

Dimensions  
**1" x 3½" x 16'**  
**1" x 4¼" x 16'**  
**MDF/UL**



Stock Code  
**1391329**

Dimensions  
**1" x 4½" x 16'**  
**MDF/UL**



Stock Code  
**1675698**

Dimensions  
**¾" x 2¾" x 16'**  
**MDF/UL**



Stock Code  
**1390847**

Dimensions  
**¾" x 3½" x 16'**  
**MDF/UL**



Stock Code  
**MP522**  
(1567173)

Dimensions  
**1<sup>1</sup>/<sub>16</sub>" x 4<sup>1</sup>/<sub>4</sub>" x 16'**

**PFJ**



Stock Code  
**1675149**

Dimensions  
**3<sup>3</sup>/<sub>4</sub>" x 3<sup>1</sup>/<sub>2</sub>" x 16'**

**MDF/UL**



Stock Code  
**1566900**

Dimensions  
**1<sup>1</sup>/<sub>16</sub>" x 3<sup>1</sup>/<sub>4</sub>" x 17'**

**MDF/UL**

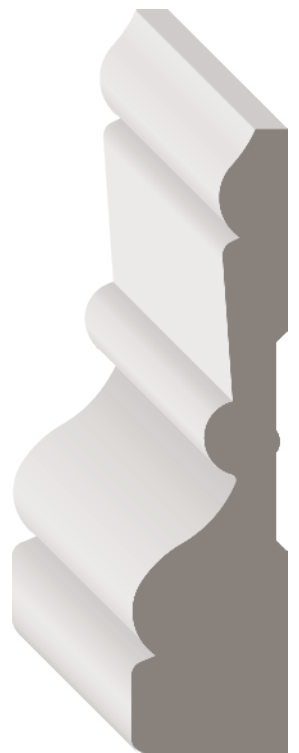

Stock Code  
**MP111**  
(1611084)

Dimensions  
**1<sup>3</sup>/<sub>16</sub>" x 3<sup>1</sup>/<sub>4</sub>" x 16'**

**PFJ**

# CASINGS

---



Stock Code  
**1677196**

Dimensions  
 $\frac{5}{8}$ " x  $2\frac{3}{4}$ " x 16'  
**MDF/UL**



Stock Code  
**1328425**  
**1626213**

Dimensions  
 $\frac{5}{8}$ " x  $3\frac{1}{4}$ " x 14'  
 $\frac{5}{8}$ " x  $3\frac{1}{4}$ " x 16'  
**MDF/UL**



Stock Code  
**MH754H**  
(1011154)

Dimensions  
 $1\frac{1}{16}$ " x  $3\frac{1}{4}$ " x RL  
**H**

**MFP754H**  
(1567003)

$1\frac{1}{16}$ " x  $3\frac{1}{4}$ " x 16'  
**MDF/UL**



Stock Code  
**MFP750H**  
(1555935)

Dimensions  
 $\frac{5}{8}$ " x  $5\frac{1}{4}$ " x 16'  
**MDF/UL**





Stock Code  
**MH100108**  
(1556014)

Dimensions  
**5/8" x 3 1/4" x 8'**

**H**



Stock Code  
**MFP908**  
(1555945)

Dimensions  
**9/16" x 3 1/4" x 14'**

**MDF/UL**



Stock Code  
**MFP340**  
(1555890)

Dimensions  
**9/16" x 3 1/8" x 14'**

**MDF/UL**



Stock Code  
**MFP907**  
(1328547)

Dimensions  
**9/16" x 2 1/4" x 14'**

**MDF/UL**

# CHAIR RAILS

## CHAIR RAILS

The chair rail runs along the wall, parallel with the baseboard. Adding a refined decor to any space, it's the subtle choice that makes a big impact. The chair rail perfectly complements a wainscot design.



Stock Code  
**1008285**

Dimensions  
**9/16" x 1 3/4" x 8'**  
**MDF/UL**



Stock Code  
**MH18412**  
(1556027)

Dimensions  
**5/8" x 2 7/16" x 12'**  
**H**

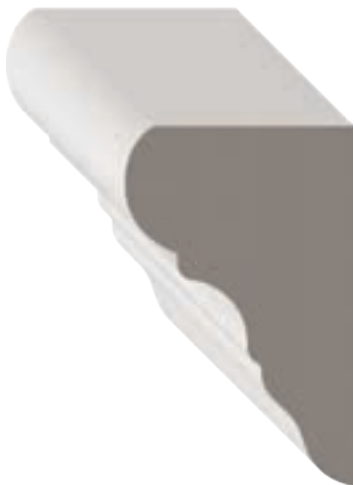

Stock Code  
**MFP409**  
(1626151)

Dimensions  
**1 1/16" x 1 7/8" x 14'**  
**MDF/UL**



Stock Code  
**1509921**

Dimensions  
**5/8" x 2 1/2" x 12'**  
**MDF/UL**



Stock Code  
**MP1000**  
(1382796)

Dimensions  
**1 1/16" x 2 5/8" x 16'**  
**PFJ**



Stock Code  
**MH297**  
(1556053)

Dimensions  
**5/8" x 3" x RL**  
**H**

**MFP297**  
(1555876)

**1 1/16" x 3" x 16'**  
**MDF/UL**

## CORNER GUARDS

## CORNER GUARDS

Corner guards are used to protect the outside edges of the wall from damage and abrasion. Corner guards come in a wide variety of sizes and detailing.



Stock Code  
**MH328208**  
(1328620)  
**MH328210**  
(1556112)

Dimensions  
**1<sup>1</sup>/<sub>16</sub>" x 1<sup>1</sup>/<sub>16</sub>" x 8'**  
**1<sup>1</sup>/<sub>16</sub>" x 1<sup>1</sup>/<sub>16</sub>" x 10'**

**H**

Stock Code  
**MP328008**  
(1556312)

Dimensions  
**1<sup>1</sup>/<sub>8</sub>" x 1<sup>1</sup>/<sub>8</sub>" x 8'**

**PFJ**

**MH328008**  
(13286190)

Dimensions  
**1<sup>1</sup>/<sub>16</sub>" x 1<sup>1</sup>/<sub>16</sub>" x 8'**

**MH328010**  
(1556110)

Dimensions  
**1<sup>1</sup>/<sub>16</sub>" x 1<sup>1</sup>/<sub>16</sub>" x 10'**

**MH20408**  
(1556029)

Dimensions  
**1<sup>1</sup>/<sub>4</sub>" x 1<sup>1</sup>/<sub>4</sub>" x 8'**

**MH20410**  
(1556030)

Dimensions  
**1<sup>1</sup>/<sub>4</sub>" x 1<sup>1</sup>/<sub>4</sub>" x 10'**

**H**

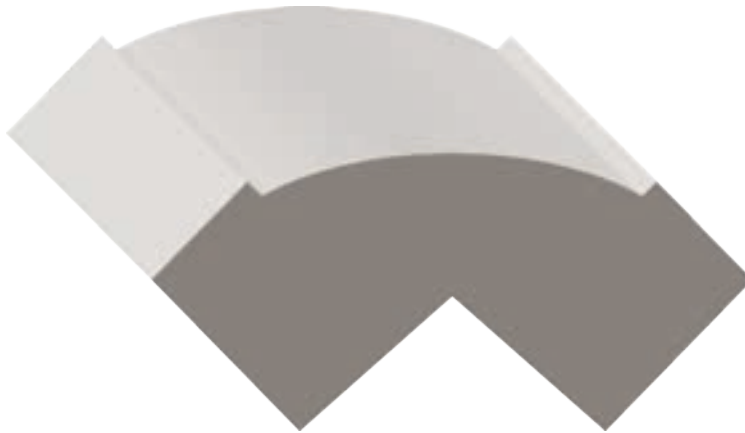

Stock Code  
**MPHOL90**  
(1556334)

Dimensions  
**2<sup>3</sup>/<sub>16</sub>" x 2<sup>3</sup>/<sub>16</sub>" x 18'**

**PFJ**



Stock Code  
**MP20208**  
(1328754)

Dimensions  
**1<sup>1</sup>/<sub>8</sub>" x 1<sup>1</sup>/<sub>8</sub>" x 8'**

**PFJ**

# COVES

## COVES

Coves are commonly used to soften the transition on inside corners but may be used for a wide range of applications.

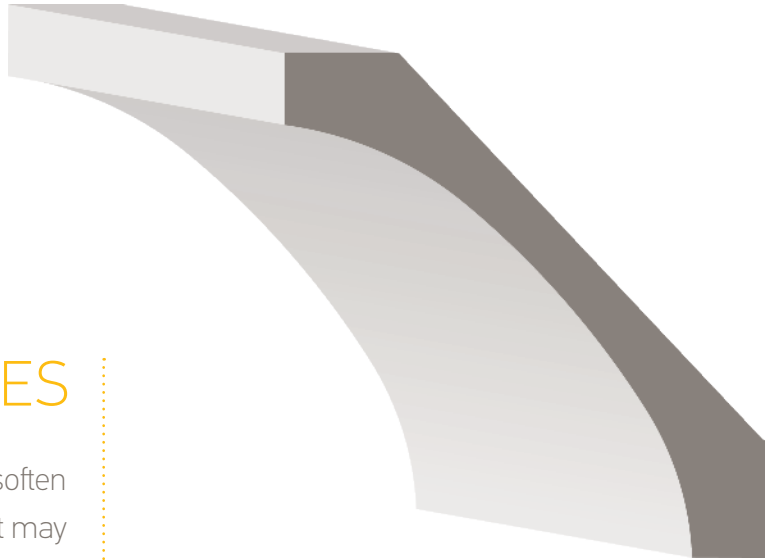

Stock Code  
**MP306**  
(1611117)

Dimensions  
**1 1/16" x 3 5/8" x 16'**

**PFJ**



Stock Code  
**MH326008**  
(1556101)

Dimensions  
**1/2" x 1/2" x 8'**

**H**



Stock Code  
**MH33408**  
(1556117)

Dimensions  
**1 1/16" x 1 1/16" x 8'**

**MH33410**  
(1556118)

**1 1/16" x 1 1/16" x 10'**

**MH33412**  
(1556119)

**1 1/16" x 1 1/16" x 12'**

**H**



Stock Code  
**MH326408**  
(1556103)

Dimensions  
**1 1/16" x 1 1/16" x 8'**

**MH326410**  
(1556104)

**1 1/16" x 1 1/16" x 10'**

**MH326412**  
(1610715)

**1 1/16" x 1 1/16" x 12'**

**H**

**MP3264**  
(1328781)

**1 1/16" x 1 1/16" x 14'**

**MP326408**  
(1556308)

**1 1/16" x 1 1/16" x 8'**

**PFJ**

# CROWNS

Cap off your look with the perfect crown.  
A great crown is the royal wrap-up  
of all your moulding decisions.

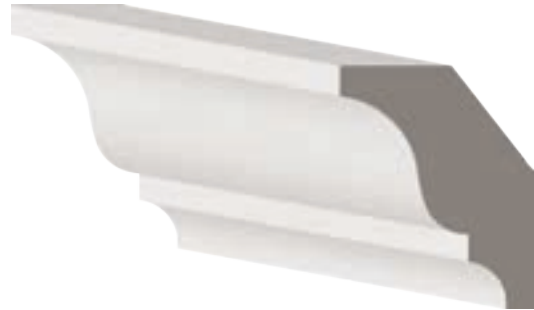

Stock Code  
**MH06812**  
(1009801)

Dimensions  
**1/2" x 1 5/8" x 12'**

**H**



Stock Code  
**MH324208**  
(1556096)

Dimensions  
**1/2" x 1 1/16" x 8'**

**MH324210**  
(1556097)

**1/2" x 1 1/16" x 10'**

**H**

**MP3242**  
(1328776)

**1/2" x 1 1/16" x 14'**

**PFJ**



Stock Code  
**MH324408**  
(1610704)

Dimensions  
**5/16" x 1 1/4" x 8'**

**MH324410**  
(1556098)

**5/16" x 1 1/4" x 10'**

**MH324412**  
(1556099)

**5/16" x 1 1/4" x 12'**

**H**

**MP3244**  
(1556305)

**5/8" x 1 3/16" x 14'**

**PFJ**



Stock Code  
**MH324812**  
(1556100)

Dimensions  
**1 3/16" x 2 1/4" x 12'**

**H**

**MP3248**  
(1556306)

**1 3/16" x 2 3/16" x 16'**

**PFJ**

# CROWNS



Stock Code  
**MH048**  
(1556004)

Dimensions  
 $\frac{1}{2}$ " x  $4\frac{3}{16}$ " x RL

**H**

**MP313**  
(1611121)

$\frac{3}{16}$ " x  $4\frac{1}{4}$ " x 16'

**PFJ**

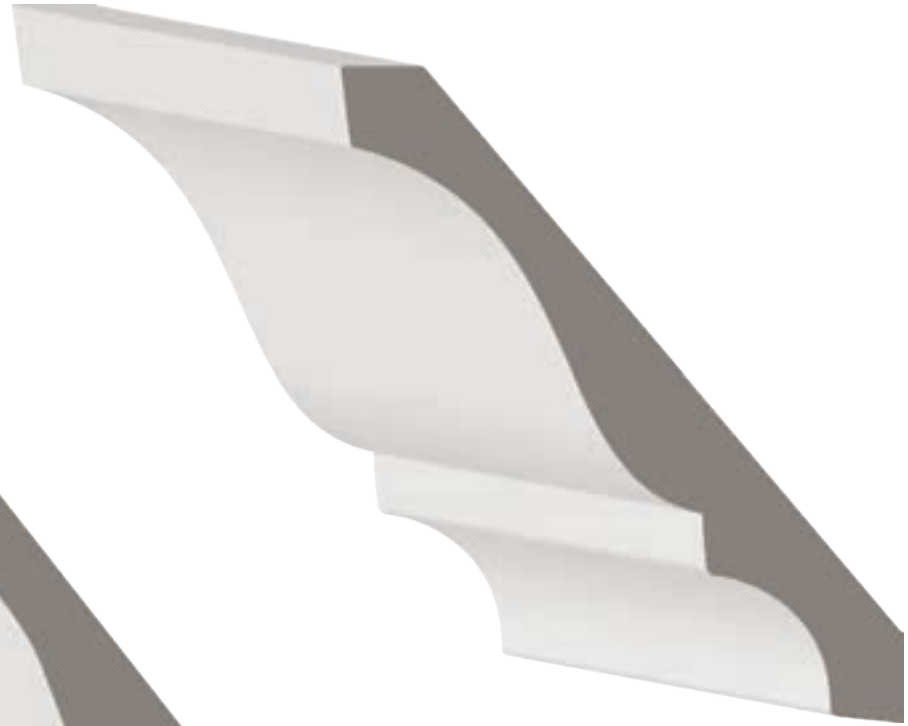

Stock Code  
**MTEK047**  
(1556486)

Dimensions  
 $\frac{5}{8}$ " x  $4\frac{1}{4}$ " x 16'

**COM**

**MFP047**  
(1626166)

$\frac{5}{8}$ " x  $4\frac{1}{4}$ " x 16'

**MDF/UL**

**MP047**  
(1328821)

$\frac{5}{16}$ " x  $4\frac{3}{16}$ " x 16'

**PFJ**

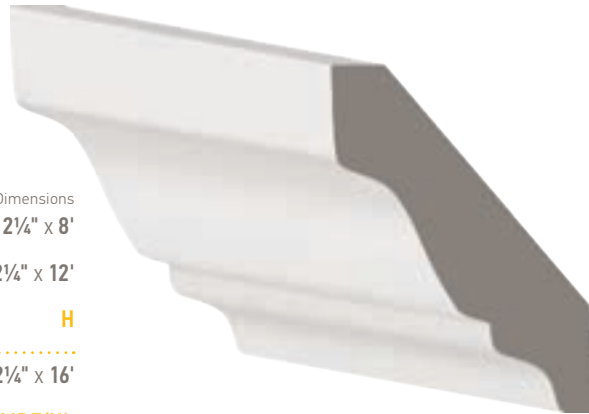

Stock Code  
**MH05408**  
(1556010)

Dimensions  
 $\frac{7}{16}$ " x  $2\frac{1}{4}$ " x 8'

**MH05412**  
(1556011)

$\frac{7}{16}$ " x  $2\frac{1}{4}$ " x 12'

**H**

**MFP054**  
(1555829)

$\frac{7}{16}$ " x  $2\frac{1}{4}$ " x 16'

**MDF/UL**

**MP054**  
(1328823)

$\frac{1}{2}$ " x  $2\frac{1}{4}$ " x 16'

**PFJ**

# CROWNS

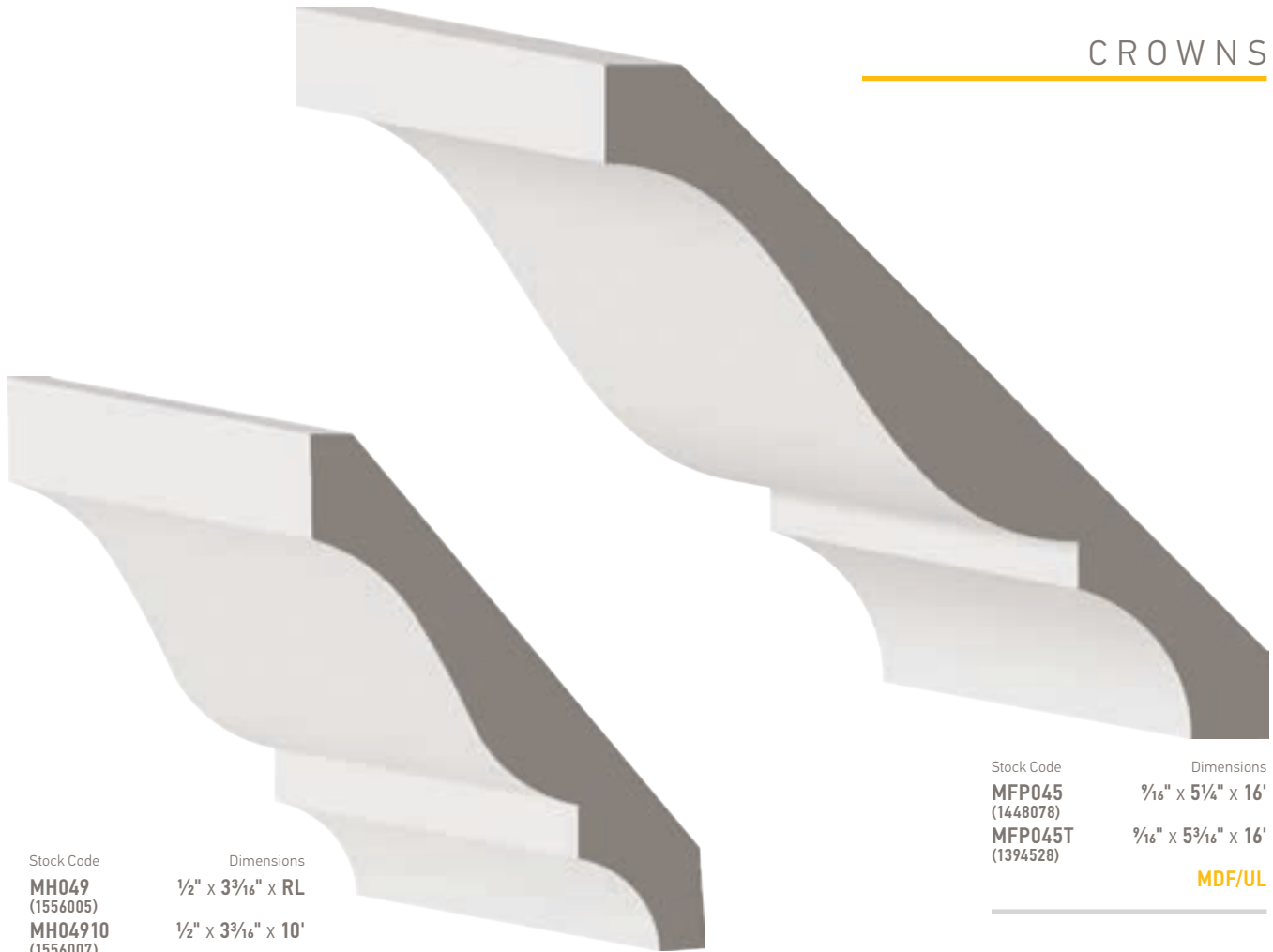

Stock Code	Dimensions
<b>MH049</b> (1556005)	1/2" x 3 3/16" x RL
<b>MH04910</b> (1556007)	1/2" x 3 3/16" x 10'
<b>MH04912</b> (1556008)	1/2" x 3 3/16" x 12'

**H**

<b>MP049</b> (1567113)	1/2" x 3 5/8" x 16'
---------------------------	---------------------

**PFJ**

Stock Code	Dimensions
<b>MFP045</b> (1448078)	3/16" x 5 1/4" x 16'
<b>MFP045T</b> (1394528)	3/16" x 5 3/16" x 16'

**MDF/UL**

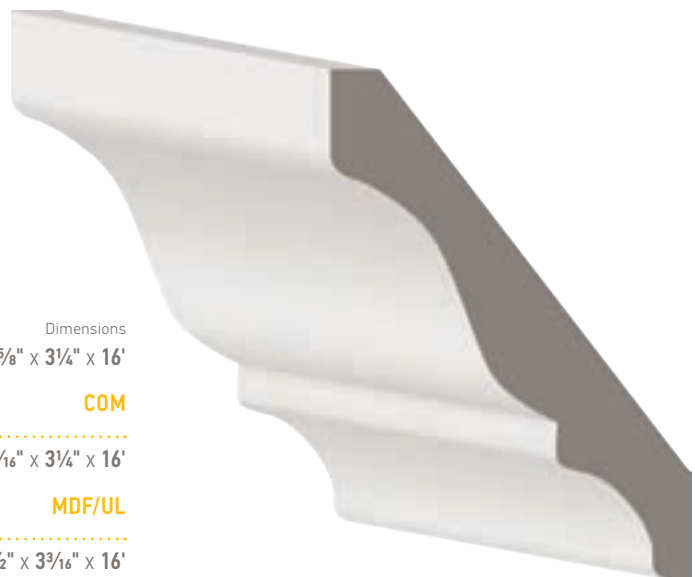

Stock Code	Dimensions
<b>MTEK051</b> (1556487)	5/8" x 3 1/4" x 16'

**COM**

<b>MFP051</b> (1555828)	3/16" x 3 1/4" x 16'
----------------------------	----------------------

**MDF/UL**

<b>MP051</b> (1328822)	1/2" x 3 3/16" x 16'
---------------------------	----------------------

**PFJ**

# CROWNS

---

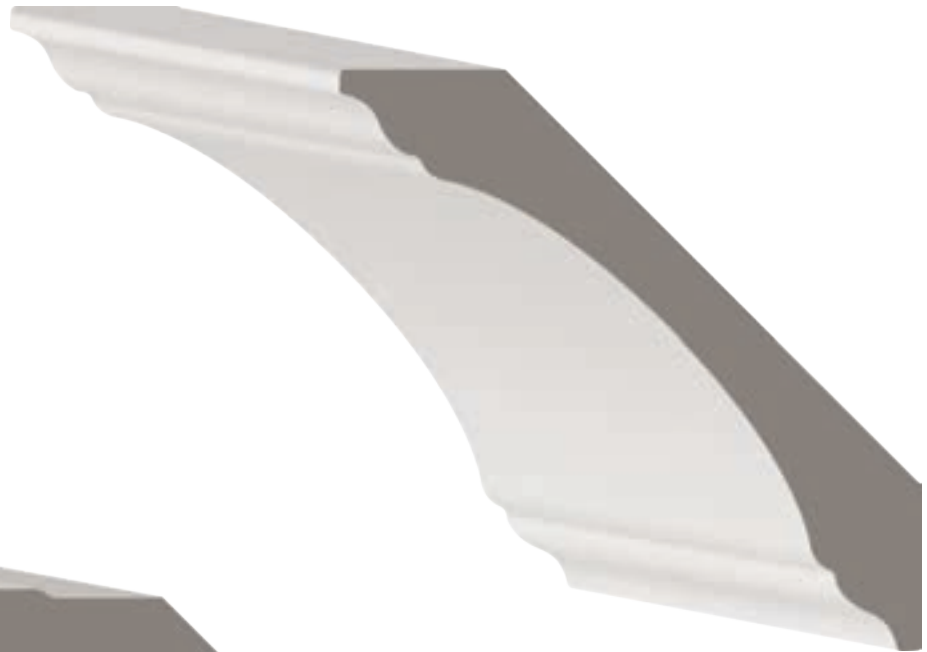

Stock Code  
**MH040**  
(1555999)

Dimensions  
**1 1/16" x 4 1/4" x RL**

**H**

---

Stock Code  
**MFP040**  
(1328500)

Dimensions  
**1 1/16" x 4 1/4" x 16'**

**MDF/UL**

---

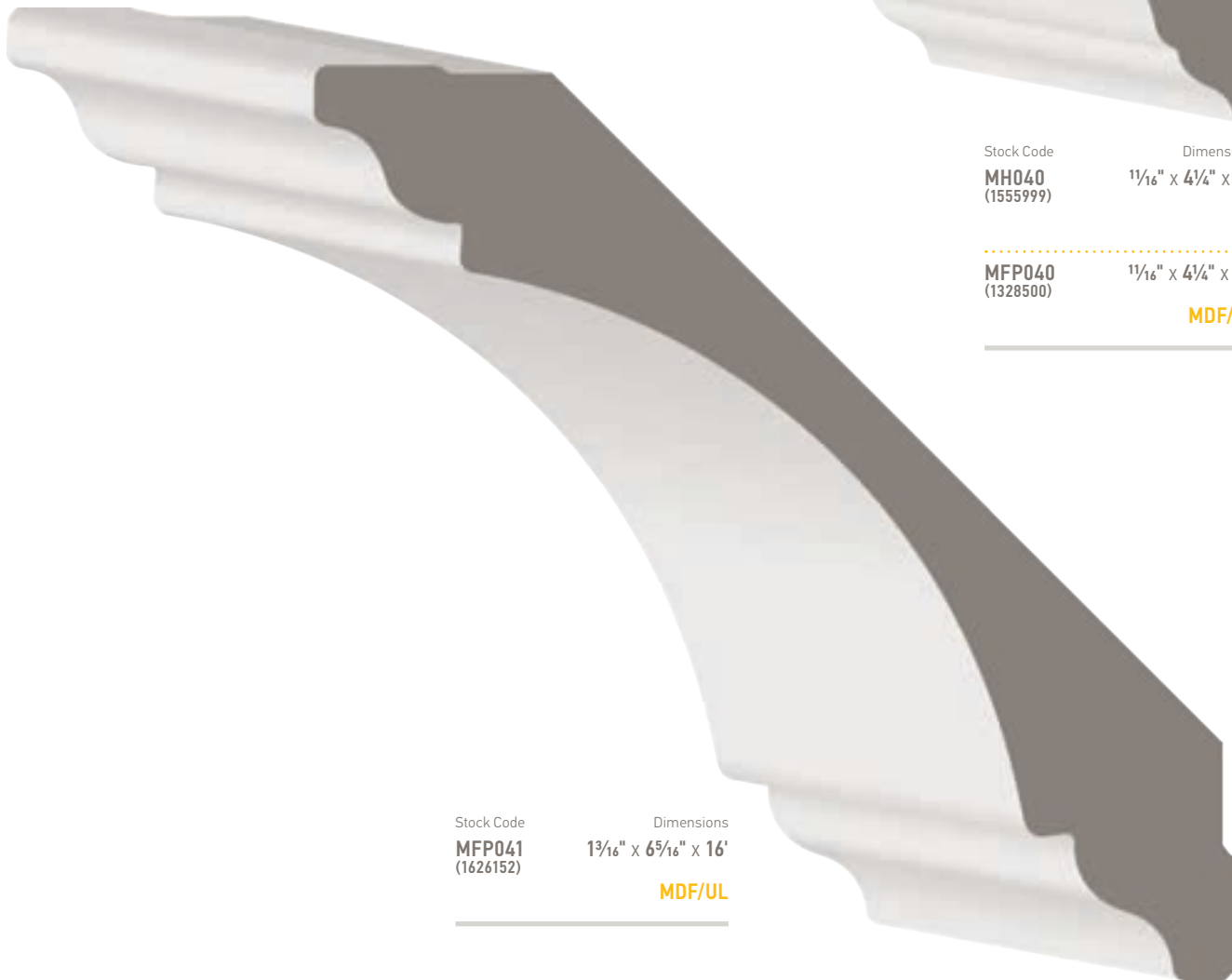

Stock Code  
**MFP041**  
(1626152)

Dimensions  
**1 3/16" x 6 5/16" x 16'**

**MDF/UL**

---



# CROWNS

---



Stock Code  
**MH168**  
(1004558)

Dimensions  
**1<sup>1</sup>/<sub>16</sub>" x 5<sup>1</sup>/<sub>4</sub>" x RL**

**H**



Stock Code  
**1328541**

Dimensions  
**1<sup>3</sup>/<sub>16</sub>" x 5<sup>1</sup>/<sub>4</sub>" x 16'**  
**MDF/UL**



Stock Code  
**MFP443**  
(1010582)

Dimensions  
**1" x 3<sup>7</sup>/<sub>16</sub>" x 16'**  
**MDF/UL**

# CROWNS

---



Stock Code  
**1318194**

Dimensions  
**3/4" x 5 1/4" x 16'**  
**MDF/UL**



Stock Code  
**MFPU901**  
(1328544)

Dimensions  
**1 3/16" x 6 3/4" x 16'**  
**MDF/UL**

# CROWNS

---

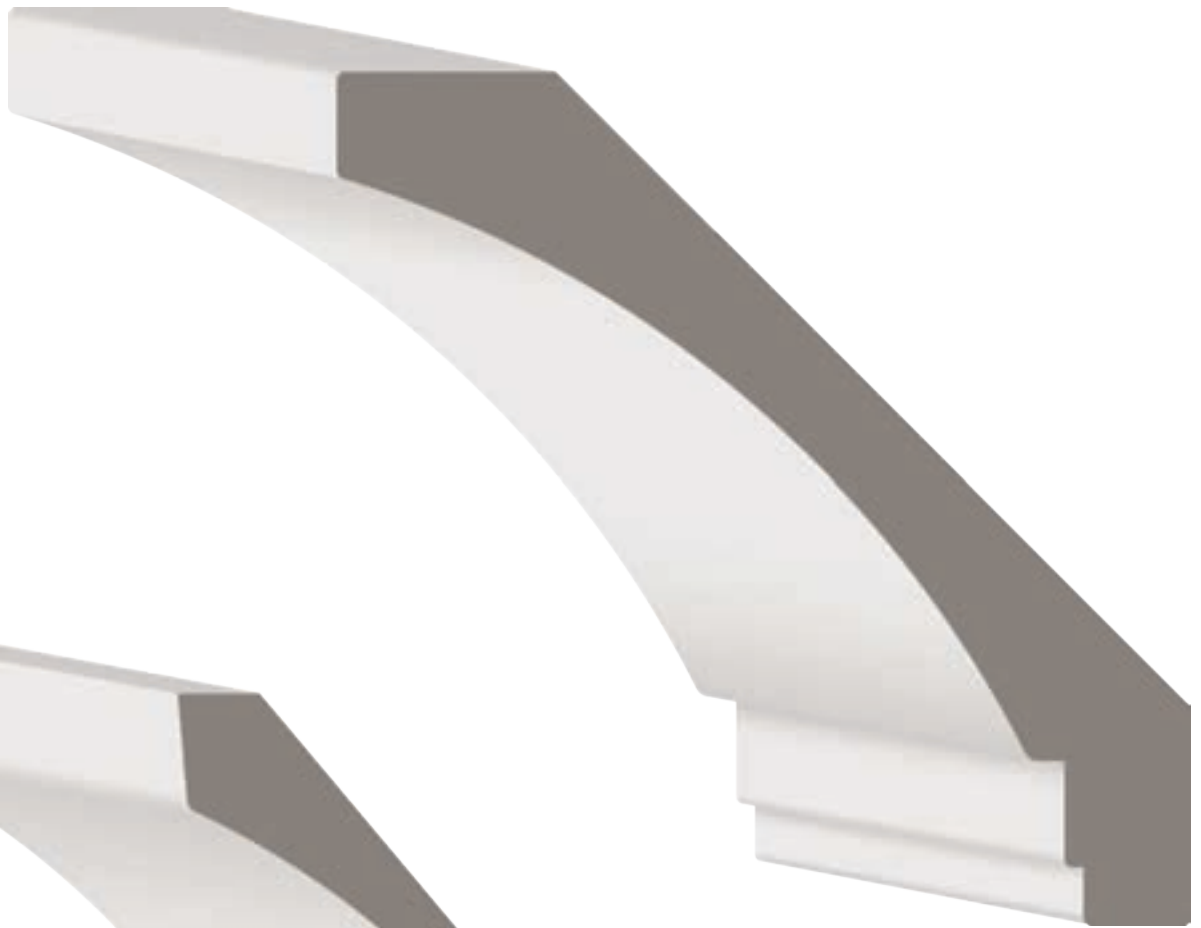

Stock Code  
**1326328**

Dimensions  
**1" x 6<sup>1</sup>/<sub>4</sub>" x 16'**  
**MDF/UL**



Stock Code  
**MP650**  
(1611161)

Dimensions  
**1<sup>1</sup>/<sub>16</sub>" x 5<sup>5</sup>/<sub>16</sub>" x 16'**

**PFJ**

# CROWNS

---



Stock Code  
**MP506**  
(1611151)

Dimensions  
**1<sup>1</sup>/<sub>16</sub>" x 3<sup>3</sup>/<sub>16</sub>" x 16'**

**PFJ**

---

Stock Code  
**1675701**

Dimensions  
**1" x 5<sup>1</sup>/<sub>4</sub>" x 16'**

**MDF/UL**

---

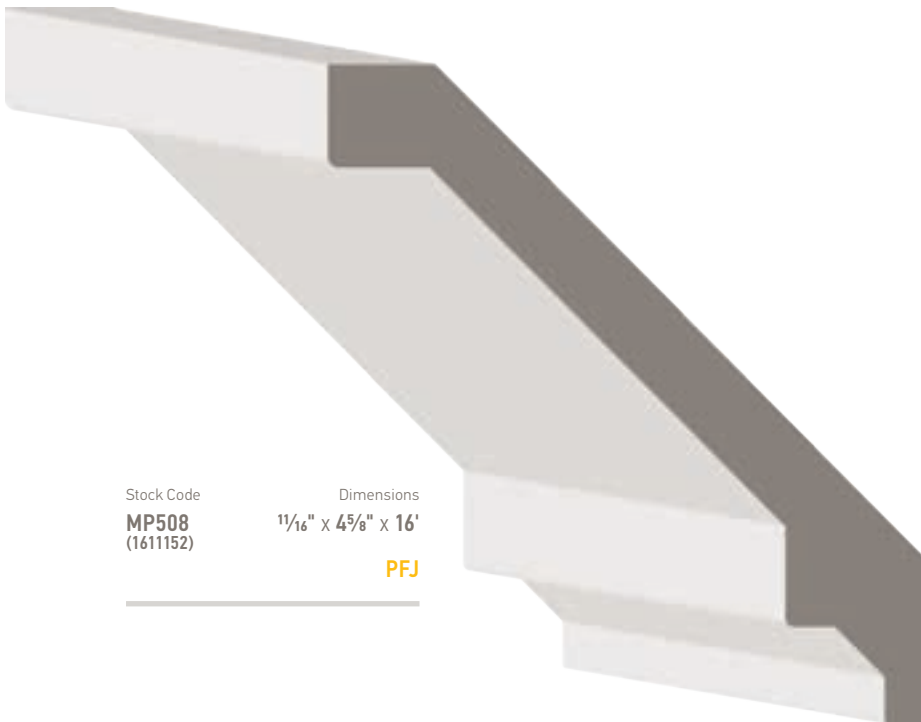

Stock Code  
**MP508**  
(1611152)

Dimensions  
**1<sup>1</sup>/<sub>16</sub>" x 4<sup>5</sup>/<sub>8</sub>" x 16'**

**PFJ**

---

## CROWNS

---



Stock Code  
**1324425**

Dimensions  
**1<sup>3</sup>/<sub>16</sub>" x 5<sup>7</sup>/<sub>16</sub>" x 16'**  
**MDF/UL**



Stock Code  
**1320094**

Dimensions  
**1" x 5<sup>11</sup>/<sub>16</sub>" x 16'**  
**MDF/UL**

# CROWNS

---



Stock Code  
**MFP043**  
(1555825)

Dimensions  
**1" x 6<sup>5</sup>/<sub>16</sub>" x 16'**

**MDF/UL**

Stock Code  
**MP550**  
(1556322)

Dimensions  
**1<sup>1</sup>/<sub>8</sub>" x 5<sup>7</sup>/<sub>16</sub>" x 16'**

**PFJ**

# CROWNS

---



Stock Code  
**1328411**

Dimensions  
**1 1/16" x 4 1/2" x 14'**  
**MDF/UL**

---

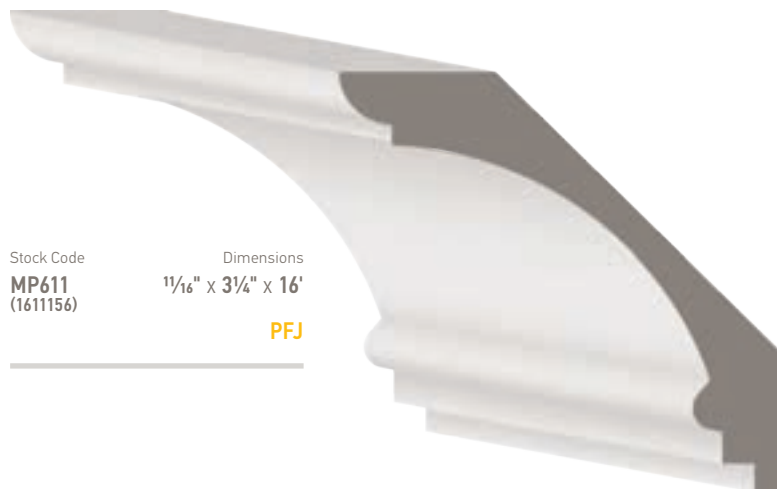

# DOOR STOPS

## DOOR STOPS

The door stop mouldings are attached to the door jamb on both sides and at the top. It is where the door comes to a rest when it is closed, stopping the door from moving any further, and covering the gap that would otherwise appear between the door and the jambs.



Stock Code  
**MH936**  
(1006795)

Dimensions  
 **$\frac{3}{8}$ " x  $1\frac{3}{8}$ " x RL**

**H**

**MP936**  
(1556330)

**$\frac{3}{8}$ " x  $1\frac{3}{16}$ " x 14'**

**PFJ**



Stock Code  
**MAK867CDAF07**  
(1609985)

Dimensions  
 **$\frac{1}{2}$ " x  $1\frac{1}{4}$ " x 7'**

**MAK87608**  
(1004214)

**$\frac{1}{2}$ " x  $1\frac{1}{2}$ " x 8'**

**ALD**

**MH86607**  
(1556190)

**$\frac{7}{16}$ " x  $1\frac{5}{16}$ " x 7'**

**MH86608**  
(1556191)

**$\frac{7}{16}$ " x  $1\frac{5}{16}$ " x 8'**

**MH86610**  
(1556192)

**$\frac{7}{16}$ " x  $1\frac{5}{16}$ " x 10'**

**MH86612**  
(1610835)

**$\frac{7}{16}$ " x  $1\frac{5}{16}$ " x 12'**

**H**



Stock Code  
**MH86508**  
(1588566)

Dimensions  
 **$\frac{7}{16}$ " x  $1\frac{1}{2}$ " x 8'**

**MH86510**  
(1556189)

**$\frac{7}{16}$ " x  $1\frac{1}{2}$ " x 10'**

**MH86908**  
(1610836)

**$\frac{7}{16}$ " x  $1\frac{1}{16}$ " x 8'**

**MH86910**  
(1610837)

**$\frac{7}{16}$ " x  $1\frac{1}{16}$ " x 10'**

**H**

**MP865**  
(1611168)

**$\frac{3}{8}$ " x  $1\frac{5}{8}$ " x 12'**

**PFJ**



Stock Code  
**MAK342208**  
(1004943)

Dimensions  
 **$\frac{3}{8}$ " x  $1\frac{3}{16}$ " x 8'**

**ALD**

**MH342207**  
(1610731)

**$\frac{3}{8}$ " x  $1\frac{3}{16}$ " x 7'**

**H**

**MP342207**  
(1328803)

**$\frac{3}{8}$ " x  $1\frac{1}{4}$ " x 7'**

**PFJ**

**MEGON342207**  
(1610161)

**$\frac{5}{16}$ " x  $1\frac{1}{4}$ " x 7'**

**PGO**



# DOOR STOPS



Stock Code  
**MFPJLSTOP**  
(1050363)

Dimensions  
 $\frac{1}{2}'' \times 1\frac{1}{16}'' \times 7'$

**MDF/UL**



Stock Code  
**1510155**

Dimensions  
 $\frac{7}{16}'' \times 1\frac{3}{16}'' \times 7'$

**PFJ**



Stock Code  
**MH59307**  
(1556167)

Dimensions  
 $\frac{1}{2}'' \times 1\frac{1}{16}'' \times 80''$

**H**



Stock Code  
**MTEKOGCHAIR**  
(1611427)

Dimensions  
 $\frac{7}{16}'' \times 3\frac{1}{4}'' \times 16'$

**COM**

**MACH593**  
(1609942)

$\frac{7}{16}'' \times 1\frac{1}{16}'' \times 14'$

**1675492**

$\frac{7}{16}'' \times 1\frac{1}{16}'' \times 14'$

**1675509**

$\frac{7}{16}'' \times 1\frac{1}{16}'' \times 14'$

**MPH**

# FLAT STOCK

## FLAT STOCK

Finished boards come in either S4S (Surfaced 4 Sides) or S3S (Surfaced 3 Sides) and are used for a multitude of purposes, including shelving, window ledges, base, casing, etc.



Stock Code	Thickness	Height	Length	Species
LAK102 (1609733)	3/4"	1-1/2"	RL	ALD
LAK103 (1555518)	3/4"	2-1/2"	RL	ALD
LAK104 (1555519)	3/4"	3-1/2"	RL	ALD
LAK10408 (1555520)	3/4"	3-1/2"	8'	ALD
LAK105 (1555521)	3/4"	4-9/16"	RL	ALD
LAK106 (1555522)	3/4"	5-1/2"	RL	ALD
LAK108 (1555523)	3/4"	7-1/4"	RL	ALD
LAK110 (1555524)	3/4"	9-1/4"	RL	ALD
LAK112 (1555525)	3/4"	11-1/4"	RL	ALD
LAK544 (1062743)	1"	3-1/2"	RL	ALD
LAK546 (1555526)	1"	5-1/2"	RL	ALD
LAK548 (1609747)	1"	7-1/4"	RL	ALD
LFVG1/02 (1609753)	1/2"	1-1/2"	RL	FIR
LFVG1/03 (1555536)	1/2"	2-1/2"	RL	FIR
LFVG1/04 (1555537)	1/2"	3-1/2"	RL	FIR
LFVG1/05 (1003639)	1/2"	4-1/2"	RL	FIR
LFVG1/06 (1555539)	1/2"	5-1/2"	RL	FIR
1670369	3/4"	1-1/2"	RL	FIR
LFVG102 (1006897)	11/16"	1-1/2"	RL	FIR
LFVG103 (1555544)	11/16"	2-1/2"	RL	FIR
LFVG10308 (1009554)	11/16"	2-1/2"	8'	FIR
LFVG104 (1555548)	11/16"	3-1/2"	RL	FIR
LFVG10408 (1555550)	11/16"	3-1/2"	8'	FIR
LFVG105 (1555553)	11/16"	4-9/16"	RL	FIR
LFVG106 (1609773)	11/16"	5-1/2"	RL	FIR
LFVG10608 (1555555)	11/16"	5-1/2"	8'	FIR
LFVG107 (1004673)	11/16"	6-9/16"	RL	FIR
LFVG108 (1609777)	11/16"	7-1/4"	RL	FIR
LFVG110 (1555561)	11/16"	9-1/4"	RL	FIR
LFVG112 (1555562)	11/16"	11-1/4"	RL	FIR
LFVG202 (1555564)	1-1/2"	1-1/2"	RL	FIR
LFVG203 (1555566)	1-1/2"	2-1/2"	RL	FIR
LFVG204 (1555567)	1-1/2"	3-1/2"	RL	FIR
LFVG206 (1555569)	1-1/2"	5-1/2"	RL	FIR
LFVG208 (1555572)	1-1/2"	7-1/4"	RL	FIR
LFVG210 (1555573)	1-1/2"	9-1/4"	RL	FIR
LFVG212 (1555574)	1-1/2"	11-1/4"	RL	FIR
LFVG404 (1555575)	3-1/2"	3-1/2"	RL	FIR
LFVG5412 (1006006)	1"	11-1/4"	RL	FIR
LFVG544 (1555577)	1"	3-1/2"	RL	FIR
LFVG545 (1007073)	1"	4-1/2"	RL	FIR
LFVG546 (1555579)	1"	5-1/2"	RL	FIR
LFVG548 (1555580)	1"	7-1/4"	RL	FIR
LHVG1/03 (1009553)	1/2"	2-1/2"	RL	H
LHVG1/04 (1006971)	1/2"	3-1/2"	RL	H
LHVG1/05 (1008226)	1/2"	4-1/2"	RL	H
LHVG1/06 (1011412)	1/2"	5-1/2"	RL	H
LHVG102 (1625886)	11/16"	1-1/2"	RL	H

Stock Code	Thickness	Height	Length	Species
LHVG10207 (1545317)	11/16"	1-1/2"	7"	H
LHVG10208 (1545318)	11/16"	1-1/2"	8"	H
LHVG10210 (1545319)	11/16"	1-1/2"	10"	H
LHVG10212 (1545320)	11/16"	1-1/2"	12"	H
LHVG103 (1555594)	11/16"	2-1/2"	RL	H
LHVG103S (1010931)	11/16"	2-1/2"	RL	H
LHVG10307 (1555596)	11/16"	2-1/2"	7"	H
LHVG10308 (1555597)	11/16"	2-1/2"	8"	H
LHVG10310 (1555598)	11/16"	2-1/2"	10"	H
LHVG10312 (1555599)	11/16"	2-1/2"	12"	H
LHVG104 (1625888)	11/16"	3-1/2"	RL	H
LHVG10407 (1555602)	11/16"	3-1/2"	7"	H
LHVG10408 (1555603)	11/16"	3-1/2"	8"	H
LHVG10410 (1609840)	11/16"	3-1/2"	10"	H
LHVG10412 (1555605)	11/16"	3-1/2"	12"	H
LHVG104S (1005116)	11/16"	3-1/2"	RL	H
LHVG105 (1328038)	11/16"	4-9/16"	RL	H
LHVG10508 (1555607)	11/16"	4-9/16"	8"	H
LHVG10510 (1609847)	11/16"	4-9/16"	10"	H
LHVG10512 (1609848)	11/16"	4-9/16"	12"	H
LHVG105S (1004878)	11/16"	4-9/16"	RL	H
LHVG106 (1555608)	11/16"	5-1/2"	RL	H
LHVG10608 (1609856)	11/16"	5-1/2"	8"	H
LHVG10610 (1007148)	11/16"	5-1/2"	10"	H
LHVG10612 (1010796)	11/16"	5-1/2"	12"	H
LHVG106S (1009433)	11/16"	5-1/2"	RL	H
LHVG107 (1555613)	11/16"	6-9/16"	RL	H
LHVG10708 (1609864)	11/16"	6-9/16"	8"	H
LHVG10710 (1609865)	11/16"	6-9/16"	10"	H
LHVG10712 (1609866)	11/16"	6-9/16"	12"	H
LHVG107S (1011152)	11/16"	6-9/16"	RL	H
LHVG108 (1625891)	11/16"	7-1/4"	RL	H
LHVG10808 (1007732)	11/16"	7-1/4"	8"	H
LHVG10810 (1004526)	11/16"	7-1/4"	10"	H
LHVG10812 (1555618)	11/16"	7-1/4"	12"	H
LHVG108S (1011007)	11/16"	7-1/4"	RL	H
LHVG110 (1555619)	11/16"	9-1/4"	RL	H
LHVG112 (1555620)	11/16"	11-1/4"	RL	H
LHVG202 (1555621)	1-1/2"	1-1/2"	RL	H
LHVG204 (1010062)	1-1/2"	3-1/2"	RL	H
LHVG206 (1011095)	1-1/2"	5-1/2"	RL	H
LHVG208 (1005716)	1-1/2"	7-1/4"	RL	H
LHVG544 (1008290)	1"	3-1/2"	RL	H
LHVG545 (1007968)	1"	4-1/2"	RL	H
LHVG546 (1002280)	1"	5-1/2"	RL	H
LHVG548 (1006688)	1"	7-1/4"	RL	H
LMP102 (1328077)	3/4"	1-1/2"	RL	MAP
LMP104 (1328085)	3/4"	3-1/2"	RL	MAP

Stock Code	Thickness	Height	Length	Species
LMP106 (1328090)	3/4"	5-1/2"	RL	MAP
LPOP1/04 (1609894)	1/2"	3-1/2"	RL	POP
LPOP1/06 (1609895)	1/2"	5-1/2"	RL	POP
LPOP102 (1625928)	3/4"	1-1/2"	RL	POP
LPOP10210 (1002101)	3/4"	1-1/2"	10"	POP
LPOP103 (1625929)	23/32"	2-1/2"	RL	POP
LPOP104 (1625930)	3/4"	3-1/2"	RL	POP
LPOP105 (1625931)	11/16"	4-9/16"	RL	POP
LPOP106 (1625932)	23/32"	5-1/2"	RL	POP
LPOP108 (1625933)	23/32"	7-1/4"	RL	POP
LPOP110 (1484185)	3/4"	9-1/4"	RL	POP
LPOP112 (1484231)	3/4"	11-1/4"	RL	POP
LPOP546 (1609908)	1-1/16"	5-1/2"	RL	POP
LPOP548 (1609909)	1-1/16"	7-1/4"	RL	POP
LRO102 (1328165)	3/4"	1-1/2"	RL	O
LRO103 (1328170)	3/4"	2-1/2"	RL	O
LRO104 (1328175)	3/4"	3-1/2"	RL	O
LRO105 (1328180)	3/4"	4-1/2"	RL	O
LRO106 (1328185)	3/4"	5-1/2"	RL	O
LRO108 (1625967)	3/4"	7-1/4"	RL	O
MACH102 (1609928)	11/16"	1-1/2"	14'	MPH
MACH104 (1609931)	11/16"	3-1/2"	14'	MPH
MACH105 (1609932)	11/16"	4-9/16"	14'	MPH
MACH106 (1609933)	11/16"	5-1/2"	14'	MPH
MACH107 (1609934)	11/16"	6-9/16"	14'	MPH
MACH108 (1609935)	11/16"	7-1/4"	14'	MPH
MACH110 (1609936)	11/16"	9-1/4"	14'	MPH
MASC102 (1610038)	21/32"	1-3/8"	14'	PCH
MASC104 (1610039)	21/32"	3-1/2"	14'	PCH
MASC105 (1555695)	5/8"	4-9/16"	14'	PCH
MASC106 (1007311)	5/8"	5-1/2"	14'	PCH
MASC107 (1009165)	21/32"	6-9/16"	14'	PCH
MASC108 (1610043)	21/32"	7-1/4"	14'	PCH
MASC110 (1610044)	11/16"	9-1/4"	14'	PCH
MAUF102 (1610078)	11/16"	1-1/2"	14'	MUF
MAUF104 (1610079)	11/16"	3-1/2"	14'	MUF
MAUF105 (1610080)	11/16"	4-9/16"	14'	MUF
MAUF106 (1610081)	11/16"	5-1/2"	14'	MUF
MAUF107 (1610082)	11/16"	6-9/16"	14'	MUF
MAUF108 (1610083)	11/16"	7-1/4"	14'	MUF
MAUF110 (1039384)	11/16"	9-1/4"	14'	MUF
MEAON102 (1555714)	21/32"	1-3/8"	14'	PAO
MEAON104 (1006601)	21/32"	3-1/2"	14'	PAO
MEAON105 (1010978)	21/32"	4-9/16"	14'	PAO
MEAON106 (1006811)	21/32"	5-1/2"	14'	PAO
MEAON107 (1009185)	21/32"	6-9/16"	14'	PAO
MEAON108 (1005712)	21/32"	7-1/4"	14'	PAO
MEAON110 (1006997)	21/32"	9-1/4"	14'	PAO

# FLAT STOCK

Stock Code	Thickness	Height	Length	Species
MEGON102 (1003290)	21/32"	1-3/8"	14'	PGO
MEGON104 (1004315)	21/32"	3-1/2"	14'	PGO
MEGON105 (1009965)	5/8"	4-9/16"	14'	PGO
MEGON106 (1009010)	21/32"	5-1/2"	14'	PGO
MEGON107 (1007575)	21/32"	6-9/16"	14'	PGO
MEGON108 (1006844)	21/32"	7-1/4"	14'	PGO
MEGON110 (1010519)	21/32"	9-1/4"	14'	PGO
MESM102 (1006392)	21/32"	1-3/8"	14'	PEM
MESM104 (1010863)	21/32"	3-1/2"	14'	PEM
MESM105 (1002287)	21/32"	4-9/16"	14'	PEM
MESM106 (1007756)	21/32"	5-1/2"	14'	PEM
MESM107 (1003679)	21/32"	6-9/16"	14'	PEM
MESM108 (1006749)	21/32"	7-1/4"	14'	PEM
MESM110 (1002728)	21/32"	9-1/4"	14'	PEM
MFP1/04 (1555835)	1/2"	3-1/2"	16'	MDF/UL
MFP1/05 (1555836)	1/2"	4-1/2"	16'	MDF/UL
MFP1/06 (1555837)	1/2"	5-1/2"	16'	MDF/UL
MFP1/08 (1555838)	1/2"	7-1/4"	16'	MDF/UL
MFP102 (1626102)	11/16"	1-1/2"	16'	MDF/UL
MFP10208 (1328228)	11/16"	1-1/2"	8'	MDF/UL
MFP10210 (1555841)	11/16"	1-1/2"	10'	MDF/UL
MFP10212 (1626016)	11/16"	1-1/2"	12'	MDF/UL
MFP103 (1566872)	11/16"	2-1/2"	16'	MDF/UL
MFP10308 (1328231)	11/16"	2-1/2"	8'	MDF/UL
MFP10310 (1555845)	11/16"	2-1/2"	10'	MDF/UL
MFP10312 (1328232)	11/16"	2-1/2"	12'	MDF/UL
MFP104 (1555846)	11/16"	3-1/2"	16'	MDF/UL
MFP10408 (1328234)	11/16"	3-1/2"	8'	MDF/UL
MFP10410 (1367570)	11/16"	3-1/2"	10'	MDF/UL
MFP10412 (1328236)	11/16"	3-1/2"	12'	MDF/UL
MFP105 (1555850)	11/16"	4-9/16"	16'	MDF/UL
MFP10508 (1328239)	11/16"	4-9/16"	8'	MDF/UL
MFP10510 (1610328)	11/16"	4-9/16"	10'	MDF/UL
MFP10512 (1328241)	11/16"	4-9/16"	12'	MDF/UL
MFP106 (1555852)	11/16"	5-1/2"	16'	MDF/UL
MFP10608 (1328245)	11/16"	5-1/2"	8'	MDF/UL
MFP10610 (1555854)	11/16"	5-1/2"	10'	MDF/UL
MFP10612 (1428878)	11/16"	5-1/2"	12'	MDF/UL
MFP107 (1555856)	11/16"	6-9/16"	16'	MDF/UL
MFP108 (1555857)	11/16"	7-1/4"	16'	MDF/UL
MFP10808 (1555858)	11/16"	7-1/4"	8'	MDF/UL
MFP10810 (1006533)	11/16"	7-1/4"	10'	MDF/UL
MFP10812 (1328251)	11/16"	7-1/4"	12'	MDF/UL
MFP110 (1555861)	11/16"	9-1/4"	16'	MDF/UL
MFP11008 (1555862)	11/16"	9-1/4"	8'	MDF/UL
MFP11010 (1555863)	11/16"	9-1/4"	10'	MDF/UL
MFP112 (1555864)	11/16"	11-1/4"	16'	MDF/UL

Stock Code	Thickness	Height	Length	Species
MFP11208 (1328252)	3/4"	11-1/4"	8'	MDF/UL
MFP11210 (1555866)	11/16"	11-1/4"	10'	MDF/UL
MFP11212 (1555867)	11/16"	11-1/4"	12'	MDF/UL
MFP413 (1003499)	11/16"	4-13/16"	16'	MDF/UL
MFP5/44 (1555913)	1"	3-1/2"	16'	MDF/UL
MFP5/45 (1555914)	1"	4-9/16"	16'	MDF/UL
MFP5/46 (1545343)	1"	5-1/2"	16'	MDF/UL
MFP5/48 (1555916)	1"	7-1/4"	16'	MDF/UL
MFSP102 (1050386)	11/16"	1-1/2"	16'	MDF/UL
MFSP103 (1610482)	11/16"	2-1/2"	14'	MDF/UL
MFSP104 (1555951)	11/16"	3-1/2"	14'	MDF/UL
MFSP105 (1050388)	11/16"	4-9/16"	16'	MDF/UL
MFSP106 (1050389)	11/16"	5-1/2"	16'	MDF/UL
MFSP107 (1555952)	11/16"	6-9/16"	16'	MDF/UL
MFSP108 (1610494)	11/16"	7-1/4"	16'	MDF/UL
MFSP112 (1610496)	11/16"	11-1/4"	16'	MDF/UL
MP1/04 (1556261)	1/2"	3-1/2"	16'	PFJ
MP1/06 (1626420)	1/2"	5-1/2"	16'	PFJ
MP102 (1677047)	21/32"	1-1/2"	16'	PFJ
MP103 (1328734)	21/32"	2-1/2"	16'	PFJ
MP104 (1328737)	21/32"	3-1/2"	16'	PFJ
MP105 (1328739)	21/32"	4-9/16"	16'	PFJ
MP106 (1328741)	21/32"	5-1/2"	16'	PFJ
MP107 (1328743)	21/32"	6-9/16"	16'	PFJ
MP108 (1328744)	21/32"	7-1/4"	16'	PFJ
MP110 (1626438)	21/32"	9-1/4"	16'	PFJ
MP112 (1626439)	21/32"	11-1/4"	16'	PFJ
MP5/44 (1556319)	1"	3-1/2"	16'	PFJ
MP5/46 (1556320)	1"	5-1/2"	16'	PFJ
MP5/48 (1556321)	1"	7-1/4"	RL	PFJ
MTEK1/04 (1611361)	1/2"	3-1/2"	16'	COM
MTEK1/06 (1588767)	1/2"	5-1/2"	16'	COM
MTEK102 (1556488)	23/32"	1-1/2"	16'	COM
MTEK103 (1556489)	11/16"	2-1/2"	16'	COM
MTEK104 (1329017)	11/16"	3-1/2"	16'	COM
MTEK105 (1556491)	11/16"	4-9/16"	16'	COM
MTEK106 (1556492)	11/16"	5-1/2"	16'	COM
MTEK107 (1556493)	11/16"	6-9/16"	16'	COM
MTEK108 (1556494)	11/16"	7-1/4"	16'	COM
MTEK110 (1556495)	11/16"	9-1/4"	16'	COM
MTEK544 (1007214)	1"	3-1/2"	16'	COM
MTEK546 (1588772)	1"	5-1/2"	16'	COM

## GLASS & SASH BEADS

Narrow wood strips or moulding used for edging against a door or window sash, or to secure glass panels to doors and windows.

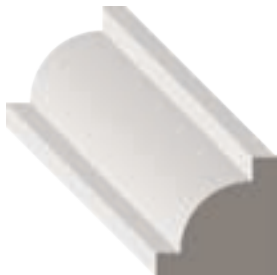

Stock Code  
**MH704**  
(1008058)

Dimensions  
 $\frac{5}{8}$ " x  $\frac{5}{8}$ " x RL

**H**

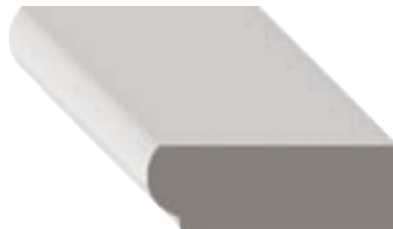

Stock Code  
**MH9531**  
(1002762)

Dimensions  
 $\frac{7}{16}$ " x  $1\frac{1}{4}$ " x 16'

**H**

**MFP953112**  $\frac{7}{16}$ " x  $1\frac{5}{16}$ " x 12'  
(1050366)

**MDF/UL**

**MP9531**  $\frac{3}{8}$ " x  $1\frac{5}{16}$ " x RL  
(1611172)

**PFJ**



Stock Code  
**MAK9532**  
(1008384)

Dimensions  
 $\frac{1}{2}$ " x  $1\frac{1}{4}$ " x RL

**ALD**

**MTEK9532**  
(1556504)

$\frac{7}{16}$ " x  $1\frac{1}{4}$ " x 12'

**COM**

**MFVG9532**  
(1555969)

$\frac{7}{16}$ " x  $1\frac{1}{4}$ " x RL

**FIR**

**MH9532**  
(1008270)

$\frac{7}{16}$ " x  $1\frac{1}{4}$ " x RL

**H**

**MFP953212**  
(1555947)

$\frac{7}{16}$ " x  $1\frac{1}{4}$ " x 12'

**MDF/UL**

# HAND RAILS

## HAND RAILS

Hand rails provide safety and support.

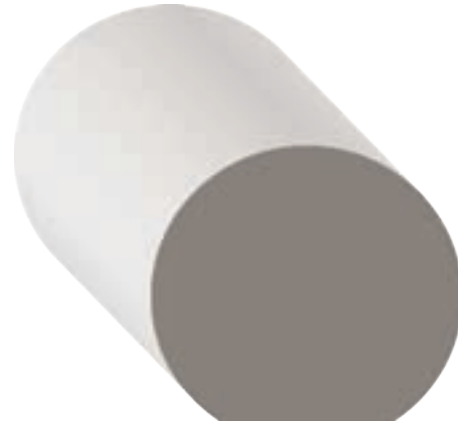

Stock Code	Dimensions
<b>MH231</b> (1556034)	1 1/16" x 1 5/8" x RL
<b>MH23108</b> (1588539)	1 7/16" x 1 5/8" x 8'
<b>MH23112</b> (1588540)	1 7/16" x 1 5/8" x 12'

H

<b>MP231</b> (1556296)	1 7/16" x 1 5/8" x 18'
---------------------------	------------------------

PFJ



Stock Code	Dimensions
<b>MH3507</b> (1341911)	1 1/4" x 2 1/4" x 8'
<b>MH350708</b> (1556128)	1 1/4" x 2 1/4" x 12'
<b>MH350712</b> (1556129)	1 1/4" x 2 1/4" x 12'
<b>MH3507DS</b> (1008100)	1 1/4" x 2 1/4" x RL

H

<b>MP3507</b> (1611136)	1 1/4" x 2 1/4" x 18'
----------------------------	-----------------------

PFJ

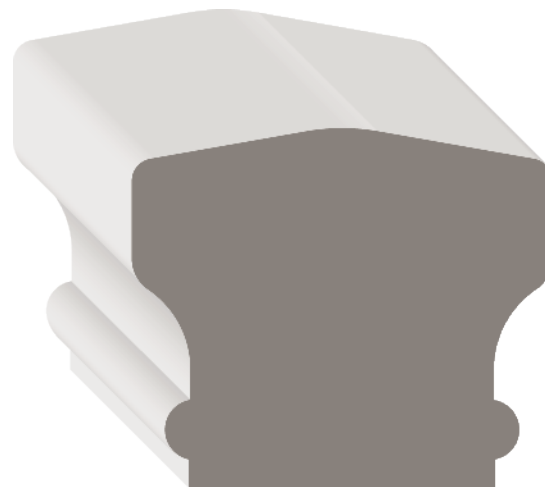

Stock Code	Dimensions
<b>1681432</b>	1 7/8" x 2 1/4" x 16'
<b>1681433</b>	1 7/8" x 2 1/4" x 18'

H

## JAMBS

The top and two sides of a door or window frame that contact the door or sash: top jamb and side jambs. The most common size for interior use is 1 1/16" thick by 4-9/16" wide.



Stock Code	Thickness	Width	Length	Species
MAKJ458C99 (1065207)	1-7/32"	4-5/8"	98"	ALD
MAKJ458F9712 (1009803)	3/4"	4-5/8"	100"	ALD
MAKJ478F86 (1609996)	3/4"	4-7/8"	86"	ALD
MAKJ49F (1555689)	3/4"	4-9/16"	82-1/4"	ALD
MAKJ658F-S09 (1555691)	3/4"	6-5/8"	81-11/16"	ALD
MAKJ658F9712 (1566843)	3/4"	6-5/8"	98-3/16"	ALD
MAKJ69FX (1009977)	3/4"	6-9/16"	84"	ALD
MEAONJ413FSA (1003615)	1-1/8"	4-13/16"	7'	PAO
MEAONJ49FSA (1009332)	1-1/16"	4-9/16"	7'	PAO
MECHJ413FSA (1039441)	1-1/8"	4-13/16"	81-5/8"	PEH
MECHJ49FSA (1039934)	1-1/8"	4-9/16"	81-5/8"	PEH
MECHJ613KS (1039446)	1-3/16"	6-13/16"	7'	PEH
MEGONJ413FSA (1005648)	1-1/8"	4-13/16"	7'	PGO
MEGONJ49F (1009251)	11/16"	4-9/16"	7'	PGO
MEGONJ49FSA (1008361)	1-1/16"	4-9/16"	7'	PGO
MEGONJ613KS (1555750)	1-3/16"	6-13/16"	7'	PGO
MESANJ49FSA (1555774)	1-1/16"	4-9/16"	7'	PEA
MESCJ413FSA (1555782)	1-1/8"	4-13/16"	7'	CHR
MESCJ49FSA (1555785)	1-1/16"	4-9/16"	7'	PCH
MESCJ613KS (1555787)	1-3/16"	6-13/16"	7'	PCH
MESMJ413FSA (1002812)	1-1/8"	4-13/16"	7'	PEM
MESMJ49FSA (1007683)	1-1/16"	4-9/16"	7'	PEM
MESMJ613KS (1007638)	1-3/16"	6-13/16"	83-1/2"	PEM
MEUFJ413FSA (1039940)	1-1/8"	4-13/16"	81-5/8"	MUF
MEUFJ49FSA (1039935)	1-1/8"	4-9/16"	81-5/8"	MUF
MEUFJ613KS (1610273)	1-3/16"	6-13/16"	7'	MUF
MFPJ413C (1555949)	1-1/16"	4-13/16"	7'	MDF/UL
MFPJ49D (1555950)	1-1/16"	4-9/16"	7'	MDF/UL
MFSPJ413C (1610514)	1-1/16"	4-13/16"	81-5/8"	MDF/UL
MFVGJ49C (1555970)	1-3/16"	4-9/16"	81-5/8"	FIR
MFVGJ49C80 (1555971)	1-3/16"	4-9/16"	98-1/16"	FIR
MFVGJ69C (1610542)	1-3/16"	6-9/16"	81-5/8"	FIR
MFVGJ69C80 (1610543)	1-3/16"	6-9/16"	97-5/8"	FIR
MFVGJ69KL (1555974)	1-3/16"	6-9/16"	83-1/2"	FIR
MFVGJ71KL80 (1555976)	1-3/16"	7-1/4"	99-3/4"	FIR
MHJ413 (1610858)	11/16"	4-13/16"	81-5/8"	H
MHJ413C (1009731)	1-3/16"	4-13/16"	97-5/8"	H
MHJ413C80 (1002202)	1-3/16"	4-13/16"	97-5/8"	H
MHJ413FSA (1556205)	1-3/16"	4-13/16"	81-5/8"	H
MHJ415C70 (1006697)	1-3/16"	4-15/16"	85-5/8"	H
MHJ49 (1556208)	11/16"	4-9/16"	81-5/8"	H*
MHJ49C80 (1005860)	1-3/16"	4-9/16"	97-5/8"	H
MHJ49D3 (1008920)	1-3/16"	4-9/16"	81-5/8"	H
MHJ49F (1556215)	11/16"	4-9/16"	82-1/4"	H
MHJ49F-S09 (1610887)	11/16"	4-9/16"	81-11/16"	H
MHJ49FSA (1052660)	1-3/16"	4-9/16"	81-5/8"	H
MHJ49FX (1328645)	11/16"	4-9/16"	83-1/2"	H
MHJ49K (1677202)	1-3/16"	4-9/16"	83-1/2"	H

\*Veneer

# JAMBS

Stock Code	Thickness	Width	Length	Species
MHJ49KL-S01 (1677153)	1-3/16"	4-9/16"	82"	H
MHJ51K (1005130)	1-3/16"	5-1/4"	83-1/2"	H
MHJ613C (1668205)	1-3/16"	6-13/16"	81-5/8"	H
MHJ613K (1002897)	1-3/16"	6-13/16"	83-1/2"	H
MHJ69F-S09 (1610919)	11/16"	6-9/16"	81-11/16"	H
MHJ69K (1676282)	1-3/16"	6-9/16"	83-1/2"	H
MHJ69KL-S01 (1006358)	1-3/16"	6-9/16"	82"	H
MHJ69K-S17 (1010953)	1-3/16"	6-9/16"	81-3/4"	H
MHJ71K70 (1003092)	1-3/16"	7-1/4"	87-1/2"	H
MPJ411C (1611180)	1-7/32"	4-11/16"	81-5/8"	PFJ
MPJ413C (1556336)	1-7/32"	4-13/16"	81-5/8"	PFJ
MPJ413C80 (1556338)	1-7/32"	4-13/16"	96"	PFJ
MPJ413C-CC (1556339)	1-3/16"	4-13/16"	81-5/8"	PFJ
MPJ413F (1556341)	11/16"	4-13/16"	82-1/4"	PFJ
MPJ413F-S09 (1556342)	11/16"	4-13/16"	81-11/16"	PFJ
MPJ413K (1556345)	1-7/32"	4-13/16"	83-1/2"	PFJ
MPJ413KS70 (1556347)	1-7/32"	4-13/16"	86"	PFJ
MPJ415C70 (1611195)	1-3/16"	4-15/16"	85-5/8"	PFJ
MPJ49C (1314628)	1-7/32"	4-9/16"	81-5/8"	PFJ
MPJ49D (1556351)	1-7/32"	4-9/16"	81-5/8"	PFJ
MPJ49C80 (1052756)	1-7/32"	4-9/16"	97-5/8"	PFJ
MPJ49D80 (1328841)	1-3/16"	4-9/16"	97-5/8"	PFJ
MPJ49DCC80 (1678943)	1-3/16"	4-9/16"	97-5/8"	PFJ
MPJ49DCC (1328842)	1-3/16"	4-9/16"	81-5/8"	PFJ
MPJ49F (1556358)	11/16"	4-9/16"	82-1/4"	PFJ
MPJ49F-S09 (1556360)	11/16"	4-9/16"	81-11/16"	PFJ
MPJ49FX (1556361)	11/16"	4-9/16"	83-1/2"	PFJ
MPJ49K (1556362)	1-7/32"	4-9/16"	83-1/2"	PFJ
MPJ49K-S01 (1556364)	1-7/32"	4-9/16"	82"	PFJ
MPJ49K-S17 (1556366)	1-7/32"	4-9/16"	81-3/4"	PFJ
MPJ51C (1556368)	1-7/32"	5-1/4"	81-5/8"	PFJ
MPJ51K (1611232)	1-7/32"	5-1/4"	83-1/2"	PFJ
MPJ613C (1556370)	1-7/32"	6-13/16"	81-5/8"	PFJ
MPJ613K-S01 (1678901)	1-7/32"	6-13/16"	82"	PFJ
MPJ613K (1556371)	1-7/32"	6-13/16"	83-1/2"	PFJ
MPJ613KS70 (1556372)	1-7/32"	6-13/16"	86-3/4"	PFJ
MPJ69C (1314632)	1-7/32"	6-9/16"	81-5/8"	PFJ
MPJ69C80 (1472593)	1-7/32"	6-9/16"	97-5/8"	PFJ
MPJ69F (1556377)	11/16"	6-9/16"	82-1/4"	PFJ
MPJ69F-S09 (1556379)	11/16"	6-9/16"	81-11/16"	PFJ
MPJ69FX (1008055)	11/16"	6-9/16"	83-1/2"	PFJ
MPJ69K (1611249)	1-7/32"	6-9/16"	83-1/2"	PFJ
MPJ69K80 (1556383)	1-7/32"	6-9/16"	100"	PFJ
MPJ69K-S01 (1556390)	1-7/32"	6-9/16"	82"	PFJ
MPJ69K-S14 (1556391)	1-7/32"	6-9/16"	81-7/8"	PFJ
MPJ69K-S17 (1556392)	1-7/32"	6-9/16"	81-3/4"	PFJ
MPJ71C (1556394)	1-7/32"	7-1/4"	81-5/8"	PFJ

Stock Code	Thickness	Width	Length	Species
MPJ71C70 (1556395)	1-7/32"	7-1/4"	85-5/8"	PFJ
MPJ71C80 (1611266)	1-7/32"	7-1/4"	97-5/8"	PFJ
MPJ71K (1556397)	1-7/32"	7-1/4"	83-1/2"	PFJ
MPJ71K80 (1556398)	1-7/32"	7-1/4"	100"	PFJ
MPJ71K-S01 (1556400)	1-7/32"	7-1/4"	82"	PFJ
MPJ71K-S17 (1556401)	1-7/32"	7-1/4"	81-3/4"	PFJ
MPJ71KS70 (1611275)	11/16"	7-1/4"	86-3/4"	PFJ
MPJ878K80 (1556403)	1-7/32"	8-7/8"	8'	PFJ
MPJ878KS70 (1611278)	1-7/32"	8-7/8"	86-3/4"	PFJ
MTEKJ413C (1009762)	1-7/32"	4-13/16"	81-5/8"	COM
MTEKJ49D (1556509)	1-7/32"	4-9/16"	81-5/8"	COM
MTEKJ613K (1011084)	1-7/32"	6-13/16"	83-1/2"	COM
MTEKJ71K (1556513)	1-7/32"	7-1/4"	83-1/2"	COM



## LINTELS

Lintels are used as an added accent to be used above doors and windows. Add this to S4S for a distinctive look.



Stock Code  
**MP504**  
(1611150)

Dimensions  
**1 7/16" x 2 3/8" x 16'**

**PFJ**



Stock Code  
**MP912**  
(1611170)

Dimensions  
**1 7/16" x 2 7/16" x 16'**

**PFJ**



Stock Code  
**MP911**  
(1611169)

Dimensions  
**1 1/4" x 2 1/4" x 16'**

**PFJ**

## PANEL & PICTURE MOULDS

The use of panel or picture moulding can be an effective and inexpensive way to frame wall paneling, paper or fabric, and add interest to walls.



Stock Code  
**MH703**  
(1002359)

Dimensions  
**1/2" x 3/4" x RL**

**H**

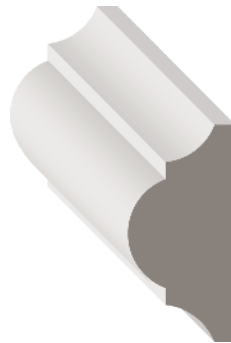

Stock Code  
**1567137**

Dimensions  
**3/4" x 1 1/8" x 16'**  
**PFJ**



Stock Code  
**MP327808**  
(1556311)

Dimensions  
**3/8" x 1 1/8" x 8'**

**PFJ**



Stock Code  
**MP503**  
(1611149)

Dimensions  
**1/2" x 1 1/8" x RL**

**PFJ**



Stock Code  
**MH022**  
(1555996)

Dimensions  
**1/2" x 1" x RL**

**H**

**MP022**  
(1556257)

**1/2" x 1" x 16'**

**PFJ**



Stock Code  
**MH270**  
(1556047)

Dimensions  
**5/8" x 1 1/8" x RL**

**H**

**MP270**  
(1611110)

**1 1/8" x 2 1/2" x RL**

**MP1010**  
(1611061)

**2 1/32" x 1 5/8" x RL**

**PFJ**

# SHIPLAPS

A wall paneling treatment made from wide wooden boards installed horizontally to create a rustic, cottage or coastal look.

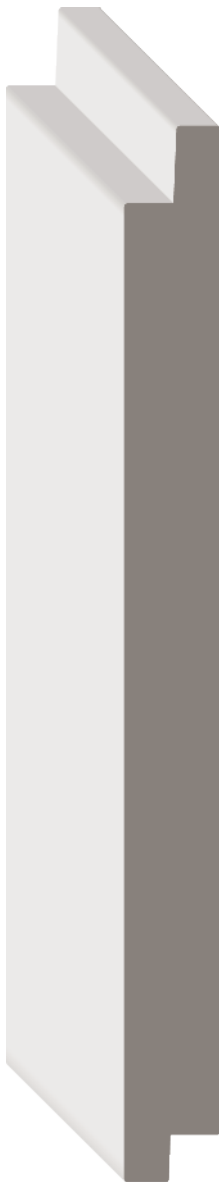

Stock Code  
**1676391**

Dimensions  
**1 1/2" x 5 1/2" x 12"**  
**COM**



Stock Code  
**1678870**

Dimensions  
**1 1/2" x 5 1/2" x 16"**  
**MDF/UL**

---

**1678753**     **1 1/2" x 5 1/2" x 16"**  
**PFJ**



Stock Code  
**1678737**

Dimensions  
**1 1/2" x 7 1/4" x 16"**  
**MDF/UL**

---

**1678742**     **1 1/2" x 7 1/4" x 16"**  
**PFJ**

# SQUARES

## SQUARES

Squares are used in the framing of shelves and cabinets, or are used to build up other profiles. Its uses are mostly utilitarian.



Stock Code **MH351708**  
(1556133)

Dimensions **1 1/16" x 1 1/16" x 8'**

H



Stock Code **MH3520**  
(1610751)

Dimensions **1 1/16" x 1 1/16" x RL**

**MH352007**  
(1610752)

Dimensions **1 1/16" x 1 1/16" x 7'**

H



Stock Code **MH3428**  
(1626361)

Dimensions **1/2" x 3/4" x RL**

**MH342808**  
(1556122)

Dimensions **1/2" x 3/4" x 8'**

**MH342810**  
(1556123)

Dimensions **1/2" x 3/4" x 10'**

H

**MP342808**  
(1448253)

Dimensions **1/2" x 3/4" x 8'**

PFJ



Stock Code **MH351608**  
(1556131)

Dimensions **3/4" x 3/4" x 8'**

**MH351610**  
(1556132)

Dimensions **3/4" x 3/4" x 10'**

H

**MP3516**  
(1328808)

Dimensions **1 1/16" x 1 1/16" x 16'**

**MP351608**  
(1556315)

Dimensions **1 1/16" x 1 1/16" x 8'**

PFJ

## TONGUE & GROOVE PANELING

Panels used to decorate or cover a wall, fitted together edge to edge using a slot and ridge on the opposite edge.



Stock Code	Dimensions
<b>MXFMG104TG</b> (1611449)	$\frac{1}{16}$ " x $3\frac{5}{16}$ " x RL
<b>MXFVG104TG</b> (1626775)	$\frac{1}{16}$ " x $3\frac{5}{16}$ " x RL
<b>FIR</b>	
<b>MXHVG104TG</b> (1011474)	$\frac{1}{16}$ " x $3\frac{5}{16}$ " x RL
<b>H</b>	
<b>MXPEX104TG</b> (1556526)	$\frac{1}{16}$ " x $3\frac{5}{16}$ " x RL
<b>PFJ</b>	



Stock Code	Dimensions
<b>MXFMG106TG</b> (1611450)	$\frac{1}{16}$ " x $5\frac{3}{8}$ " x RL
<b>MXFVG106TG</b> (1556523)	$\frac{1}{16}$ " x $5\frac{3}{8}$ " x RL
<b>FIR</b>	
<b>MXHVG106TG</b> (1009976)	$\frac{1}{16}$ " x $5\frac{3}{8}$ " x RL
<b>H</b>	
<b>MXPEX106TG</b> (1556527)	$\frac{1}{16}$ " x $5\frac{3}{8}$ " x RL
<b>PFJ</b>	



Stock Code	Dimensions
<b>MXFMG104FLOOR</b> (1003124)	$\frac{3}{4}$ " x $3\frac{3}{8}$ " x RL
<b>FIR</b>	

# WAINSCOT CAPS

## WAINSCOT CAPS

A wainscot cap is used to finish the top edge of a wainscot wall treatment. It may also be used as one component of a larger chair rail profile.



Stock Code  
**MFP850**  
(1626091)

Dimensions  
**1 1/16" x 1 3/4" x 8'**

**MDF/UL**



Stock Code  
**MP780**  
(1611167)

Dimensions  
**1" x 1 5/8" x 16'**

**PFJ**



Stock Code  
**MH29208**  
(1556050)

Dimensions  
**3/16" x 1 1/8" x 8'**

**MH29210**  
(1556051)

**3/16" x 1 1/8" x 10'**

**H**



Stock Code  
**MH702**  
(1556181)

Dimensions  
**5/8" x 1 3/8" x RL**

**H**



Stock Code  
**MH706**  
(1556184)

Dimensions  
**3/4" x 2" x RL**

**H**

## MISCELLANEOUS

### BED MOULDS

Similar to crown moulding, used to cover the joint between the ceiling and wall. Can be either sprung or plain, or flush to the wall as an extension of a cornice mould.



Stock Code  
**MH07512**  
(1556013)

Dimensions  
**1/2" x 1 5/8" x 12'**

H

### HALF ROUNDS

A cross section of a half round looks like a half circle and is used primarily as decorative trim. It works well as a trim piece for wallpaper or to add a decorative pattern to flat panels. This profile can also be used to put a rounded edge on various shelving.



Stock Code  
**MH321208**  
(1556086)

Dimensions  
**3/8" x 3/4" x 8'**

H

### CHAMFER STRIPS

Utilized where kitchen cabinet tops meet the walls or as a linoleum cove. Sometimes used for window applications.



Stock Code  
**MH995**  
(1556198)

Dimensions  
**3/4" x 3/4" x RL**

H

### FULL ROUNDS

Full rounds are used for numerous purposes and projects. Some of the more common uses are closet poles, curtain rods and towel rods.



Stock Code  
**MH3226**  
(1328607)

Dimensions  
**1 5/16" x 1 5/16" x RL**

Stock Code  
**MH322608**  
(1556091)

Dimensions  
**1 5/16" x 1 5/16" x 8'**

Stock Code  
**MH322610**  
(1556092)

Dimensions  
**1 5/16" x 1 5/16" x 10'**

Stock Code  
**MH322612**  
(1556093)

Dimensions  
**1 5/16" x 1 5/16" x 12'**

Stock Code  
**MH3226DS**  
(1005892)

Dimensions  
**1 5/16" x 1 5/16" x RL**

Stock Code  
**MH3228**  
(1328609)

Dimensions  
**1 1/2" x 1 1/2" x RL**

Stock Code  
**MH322808**  
(1610700)

Dimensions  
**1 1/2" x 1 1/2" x 8'**

H

# MISCELLANEOUS

## SCREEN MOULDS

A very versatile profile; screen mould fits a wide variety of needs and uses. Traditionally used to hold mesh screening into wood screens, it also works well as edge trim on various shelving or wood trim for wallpaper.



Stock Code  
**MH327408**  
(1556107)  
**MH327410**  
(1556108)

Dimensions  
 $\frac{1}{4}'' \times \frac{3}{4}'' \times 8'$   
 $\frac{1}{4}'' \times \frac{3}{4}'' \times 10'$

H

**MP327408**  
(1556309)

$\frac{1}{4}'' \times \frac{3}{4}'' \times 8'$

PFJ

## LATTICE

A thin strip of flat moulding commonly used to hide seams and edges.



Stock Code  
**MH26808**  
(1556045)  
**MH26810**  
(1556046)  
**MH26812**  
(1610644)  
**MH26708**  
(1556042)

Dimensions  
 $\frac{1}{4}'' \times 1\frac{1}{8}'' \times 8'$   
 $\frac{1}{4}'' \times 1\frac{1}{8}'' \times 10'$   
 $\frac{1}{4}'' \times 1\frac{1}{8}'' \times 12'$   
 $\frac{1}{4}'' \times 1\frac{3}{8}'' \times 8'$

H



Stock Code  
**MFVG3288**  
(1555957)

Dimensions  
 $\frac{7}{16}'' \times 1\frac{1}{16}'' \times \text{RL}$

FIR

**MH32888**  
(1328622)

$\frac{7}{16}'' \times 1\frac{1}{16}'' \times \text{RL}$

**MH328808**  
(1556114)

$\frac{7}{16}'' \times 1\frac{1}{16}'' \times 8'$

**MH328810**  
(1556115)

$\frac{7}{16}'' \times 1\frac{1}{16}'' \times 10'$

**MH328812**  
(1556116)

$\frac{7}{16}'' \times 1\frac{1}{16}'' \times 12'$

H

**MP129**  
(1382479)

$\frac{7}{16}'' \times 1\frac{1}{16}'' \times 16'$

PFJ

## BASE SHOES

Commonly used to trim flooring materials and in combination with a traditional baseboard to conceal variations between the flooring and the base. This versatile profile solves numerous trimming needs.

## QUARTER ROUNDS

Quarter Rounds come in several sizes and serve a variety of functions. They are most often used with baseboards.



Stock Code  
**MH320008**  
(1626335)  
**MH320208**  
(1556079)  
**MH320210**  
(1556080)  
**MH320608**  
(1556081)  
**MH320610**  
(1556082)  
**MH320612**  
(1610687)

Dimensions  
 $\frac{1}{4}'' \times \frac{1}{4}'' \times 8'$   
 $\frac{1}{2}'' \times \frac{1}{2}'' \times 8'$   
 $\frac{1}{2}'' \times \frac{1}{2}'' \times 10'$   
 $1\frac{1}{16}'' \times 1\frac{1}{16}'' \times 8'$   
 $1\frac{1}{16}'' \times 1\frac{1}{16}'' \times 10'$   
 $1\frac{1}{16}'' \times 1\frac{1}{16}'' \times 12'$

H

**MR03206**  
(1626639)

$\frac{3}{4}'' \times \frac{3}{4}'' \times \text{RL}$

O

**MP3206**  
(1328773)

$1\frac{1}{16}'' \times 1\frac{1}{16}'' \times 14'$

**MP320608**  
(1556303)

$1\frac{1}{16}'' \times 1\frac{1}{16}'' \times 8'$

PFJ



## MISCELLANEOUS



### WAINSCOT

Trimwork installed in the area below a chair rail. Numerous options are available including raised panel, shadow box and beaded. Combined with a chair rail and baseboard, wainscoting creates a dramatic look in any room.

Stock Code

**MFP222**  
(1002119)

Dimensions

**3/8" x 5 3/4" x 10'**

**MDF/UL**

### STAIR TREADS



Stock Code

**MFTKTREAD06**  
(1610517)

**MFTKTREAD08**  
(1610518)

**MFVGTREAD**  
(1610549)

Dimensions

**1 1/16" x 11 1/2" x 6'**

**1 1/16" x 11 1/2" x 8'**

**1" x 11 1/4" x RL**

**FIR**



# INDEX

Stock Code	Profile Type	Dimensions	Species	Page
1008285	Chair Rail	9/16" x 1-3/4" x 8'	MDF/UL	42
1318184	Baseboard	5/8" x 5-1/2" x 16'	MDF/UL	23
1318194	Crown	3/4" x 5-1/4" x 16'	MDF/UL	50
1318199	Baseboard	3/4" x 5-1/2" x 16'	MDF/UL	22
1318202	Baseboard	3/4" x 7-1/4" x 16'	MDF/UL	22
1320094	Crown	1" x 5-11/16" x 16'	MDF/UL	53
1322025	Architrave	1-1/2" x 5" x 12'	MDF/UL	7
1323953	Baseboard	9/16" x 4-1/2" x 16'	MDF/UL	24
1323956	Baseboard	9/16" x 5-1/2" x 16'	MDF/UL	24
1324425	Crown	1-3/16" x 5-7/16" x 16'	MDF/UL	53
1324430	Architrave	1-1/2" x 6-1/2" x 12'	MDF/UL	7
1324433	Baseboard	3/4" x 5-1/2" x 16'	MDF/UL	22
1324436	Baseboard	3/4" x 7-1/4" x 16'	MDF/UL	22
1326328	Crown	1-1/4" x 6-1/4" x 16'	MDF/UL	51
1328399	Baseboard	5/8" x 5" x 14'	MDF/UL	19
1328411	Crown	11/16" x 4-1/2" x 14'	MDF/UL	55
1328425	Casing	5/8" x 3-1/4" x 14'	MDF/UL	40
1328514	Architrave	1-1/2" x 5-1/2" x 12'	MDF/UL	7
1328537	Baseboard	1/2" x 6" x 14'	MDF/UL	24
1328541	Crown	1-3/16" x 5-1/4" x 16'	MDF/UL	49
1390847	Casing	3/4" x 3-1/2" x 16'	MDF/UL	38
1391329	Casing	1" x 4-1/2" x 16'	MDF/UL	38
1509921	Chair Rail	5/8" x 2-1/2" x 12'	MDF/UL	42
1510155	Door Stop	7/16" x 1-3/16" x 7'	PFJ	57
1544824	Back Band	5/32" x 1-1/2" x 16'	POP	11
1566900	Casing	11/16" x 3-1/4" x 17'	MDF/UL	39
1566981	Baseboard	9/16" x 5-3/8" x 16'	MDF/UL	19
1567137	Panel Mould	9/16" x 1-1/8" x 16'	PFJ	66
1626213	Casing	5/8" x 3-1/4" x 16'	MDF/UL	40
1626223	Baseboard	1/2" x 6" x 16'	MDF/UL	24
1670311	Casing	11/16" x 3-1/2" x 16'	PFJ	36
1670369	Flat Stock	3/4" x 1-1/2" x RL	FIR	58
1675149	Casing	3/4" x 3-1/2" x 16'	MDF/UL	39
1675150	Casing	1" x 3-1/2" x 16'	MDF/UL	35
1675492	Door Stop	7/16" x 1-11/16" x 14'	MPH	57
1675509	Door Stop	7/16" x 1-11/16" x 14'	MPH	57
1675698	Casing	3/4" x 2-3/4" x 16'	MDF/UL	38
1675700	Casing	1" x 3-1/2" x 16'	MDF/UL	38
1675701	Crown	1" x 5-1/4" x 16'	MDF/UL	52
1675702	Casing	1" x 4-1/4" x 16'	MDF/UL	38
1676391	Shiplap	1/2" x 5-1/2" x 12'	COM	67
1677196	Casing	5/8" x 2-3/4" x 16'	MDF/UL	40
1677449	Baseboard	1/2" x 5" x 16'	MDF/UL	24
1677969	Architrave	1-1/2" x 5-1/2" x 16'	MDF/UL	7
1678737	Shiplap	1/2" x 7-1/4" x 16'	MDF/UL	67
1678742	Shiplap	1/2" x 7-1/4" x 16'	PFJ	67
1678753	Shiplap	1/2" x 5-1/2" x 16'	PFJ	67
1678870	Shiplap	1/2" x 5-1/2" x 16'	MDF/UL	67
1681176	Casing	9/16" x 2-1/4" x 81-1/4"	MDF/UL	29
1681178	Casing	9/16" x 2-1/4" x 81-1/4"	COM	29
1681432	Hand Rail	1-7/8" x 2-1/4" x 16'	H	62
1681433	Hand Rail	1-7/8" x 2-1/4" x 18'	H	62
LAK102 (1609733)	Flat Stock	3/4" x 1-1/2" x RL	ALD	58
LAK103 (1555518)	Flat Stock	3/4" x 2-1/2" x RL	ALD	58

Stock Code	Profile Type	Dimensions	Species	Page
LAK104 (1555519)	Flat Stock	3/4" x 3-1/2" x RL	ALD	58
LAK10408 (1555520)	Flat Stock	3/4" x 3-1/2" x 8'	ALD	58
LAK105 (1555521)	Flat Stock	3/4" x 4-9/16" x RL	ALD	58
LAK106 (1555522)	Flat Stock	3/4" x 5-1/2" x RL	ALD	58
LAK108 (1555523)	Flat Stock	3/4" x 7-1/4" x RL	ALD	58
LAK110 (1555524)	Flat Stock	3/4" x 9-1/4" x RL	ALD	58
LAK112 (1555525)	Flat Stock	3/4" x 11-1/2" x RL	ALD	58
LAK544 (1062743)	Flat Stock	1" x 3-1/2" x RL	ALD	58
LAK546 (1555526)	Flat Stock	1" x 5-1/2" x RL	ALD	58
LAK548 (1609747)	Flat Stock	1" x 7-1/4" x RL	ALD	58
LFVG102 (1609753)	Flat Stock	1/2" x 1-1/2" x RL	FIR	58
LFVG103 (1555536)	Flat Stock	1/2" x 2-1/2" x RL	FIR	58
LFVG104 (1555537)	Flat Stock	1/2" x 3-1/2" x RL	FIR	58
LFVG105 (1003639)	Flat Stock	1/2" x 4-1/2" x RL	FIR	58
LFVG106 (1555539)	Flat Stock	1/2" x 5-1/2" x RL	FIR	58
LFVG102 (1006897)	Flat Stock	11/16" x 1-1/2" x RL	FIR	58
LFVG103 (1555544)	Flat Stock	11/16" x 2-1/2" x RL	FIR	58
LFVG10308 (1009554)	Flat Stock	11/16" x 2-1/2" x 8'	FIR	58
LFVG104 (1555548)	Flat Stock	11/16" x 3-1/2" x RL	FIR	58
LFVG10408 (1555550)	Flat Stock	11/16" x 3-1/2" x 8'	FIR	58
LFVG105 (1555553)	Flat Stock	11/16" x 4-9/16" x RL	FIR	58
LFVG106 (1609773)	Flat Stock	11/16" x 5-1/2" x RL	FIR	58
LFVG10608 (1555555)	Flat Stock	11/16" x 5-1/2" x 8'	FIR	58
LFVG107 (1004673)	Flat Stock	11/16" x 6-9/16" x RL	FIR	58
LFVG108 (1609777)	Flat Stock	11/16" x 7-1/4" x RL	FIR	58
LFVG110 (1555561)	Flat Stock	11/16" x 9-1/4" x RL	FIR	58
LFVG112 (1555562)	Flat Stock	11/16" x 11-1/4" x RL	FIR	58
LFVG202 (1555564)	Flat Stock	1-1/2" x 1-1/2" x RL	FIR	58
LFVG203 (1555566)	Flat Stock	1-1/2" x 2-1/2" x RL	FIR	58
LFVG204 (1555567)	Flat Stock	1-1/2" x 3-1/2" x RL	FIR	58
LFVG206 (1555569)	Flat Stock	1-1/2" x 5-1/2" x RL	FIR	58
LFVG208 (1555572)	Flat Stock	1-1/2" x 7-1/4" x RL	FIR	58
LFVG210 (1555573)	Flat Stock	1-1/2" x 9-1/4" x RL	FIR	58
LFVG212 (1555574)	Flat Stock	1-1/2" x 11-1/4" x RL	FIR	58
LFVG404 (1555575)	Flat Stock	3-1/2" x 3-1/2" x RL	FIR	58
LFVG5412 (1006006)	Flat Stock	1" x 11-1/4" x RL	FIR	58
LFVG544 (1555577)	Flat Stock	1" x 3-1/2" x RL	FIR	58
LFVG545 (1007073)	Flat Stock	1" x 4-1/2" x RL	FIR	58
LFVG546 (1555579)	Flat Stock	1" x 5-1/2" x RL	FIR	58
LFVG548 (1555580)	Flat Stock	1" x 7-1/4" x RL	FIR	58
LHVG103 (1009553)	Flat Stock	1/2" x 2-1/2" x RL	H	58
LHVG104 (1006971)	Flat Stock	1/2" x 3-1/2" x RL	H	58
LHVG105 (1008226)	Flat Stock	1/2" x 4-1/2" x RL	H	58
LHVG106 (1011412)	Flat Stock	1/2" x 5-1/2" x RL	H	58
LHVG102 (1625886)	Flat Stock	11/16" x 1-1/2" x RL	H	58
LHVG10207 (1545317)	Flat Stock	11/16" x 1-1/2" x 7'	H	59
LHVG10208 (1545318)	Flat Stock	11/16" x 1-1/2" x 8'	H	59
LHVG10210 (1545319)	Flat Stock	11/16" x 1-1/2" x 10'	H	59
LHVG10212 (1545320)	Flat Stock	11/16" x 1-1/2" x 12'	H	59
LHVG103 (1555594)	Flat Stock	11/16" x 2-1/2" x RL	H	59
LHVG10307 (1555596)	Flat Stock	11/16" x 2-1/2" x 7'	H	59
LHVG10308 (1555597)	Flat Stock	11/16" x 2-1/2" x 8'	H	59
LHVG10310 (1555598)	Flat Stock	11/16" x 2-1/2" x 10'	H	59
LHVG10312 (1555599)	Flat Stock	11/16" x 2-1/2" x 12'	H	59

# INDEX

Stock Code	Profile Type	Dimensions	Species	Page
LHVG103S (1010931)	Flat Stock	$\frac{11}{16}'' \times 2\text{-}1/2'' \times \text{RL}$	<b>H</b>	59
LHVG104 (1625888)	Flat Stock	$\frac{11}{16}'' \times 3\text{-}1/2'' \times \text{RL}$	<b>H</b>	59
LHVG10407 (1555602)	Flat Stock	$\frac{11}{16}'' \times 3\text{-}1/2'' \times 7'$	<b>H</b>	59
LHVG10408 (1555603)	Flat Stock	$\frac{11}{16}'' \times 3\text{-}1/2'' \times 8'$	<b>H</b>	59
LHVG10410 (1609840)	Flat Stock	$\frac{11}{16}'' \times 3\text{-}1/2'' \times 10'$	<b>H</b>	59
LHVG10412 (1555605)	Flat Stock	$\frac{11}{16}'' \times 3\text{-}1/2'' \times 12'$	<b>H</b>	59
LHVG1045 (1005116)	Flat Stock	$\frac{11}{16}'' \times 3\text{-}1/2'' \times \text{RL}$	<b>H</b>	59
LHVG105 (1328038)	Flat Stock	$\frac{11}{16}'' \times 4\text{-}9/16'' \times \text{RL}$	<b>H</b>	59
LHVG10508 (1555607)	Flat Stock	$\frac{11}{16}'' \times 4\text{-}9/16'' \times 8'$	<b>H</b>	59
LHVG10510 (1609847)	Flat Stock	$\frac{11}{16}'' \times 4\text{-}9/16'' \times 10'$	<b>H</b>	59
LHVG10512 (1609848)	Flat Stock	$\frac{11}{16}'' \times 4\text{-}9/16'' \times 12'$	<b>H</b>	59
LHVG1055 (1004878)	Flat Stock	$\frac{11}{16}'' \times 4\text{-}9/16'' \times \text{RL}$	<b>H</b>	59
LHVG106 (1555608)	Flat Stock	$\frac{11}{16}'' \times 5\text{-}1/2'' \times \text{RL}$	<b>H</b>	59
LHVG10608 (1609856)	Flat Stock	$\frac{11}{16}'' \times 5\text{-}1/2'' \times 8'$	<b>H</b>	59
LHVG10610 (1007148)	Flat Stock	$\frac{11}{16}'' \times 5\text{-}1/2'' \times 10'$	<b>H</b>	59
LHVG10612 (1010796)	Flat Stock	$\frac{11}{16}'' \times 5\text{-}1/2'' \times 12'$	<b>H</b>	59
LHVG1065 (1009433)	Flat Stock	$\frac{11}{16}'' \times 5\text{-}1/2'' \times \text{RL}$	<b>H</b>	59
LHVG107 (1555613)	Flat Stock	$\frac{11}{16}'' \times 6\text{-}9/16'' \times \text{RL}$	<b>H</b>	59
LHVG10708 (1609864)	Flat Stock	$\frac{11}{16}'' \times 6\text{-}9/16'' \times 8'$	<b>H</b>	59
LHVG10710 (1609865)	Flat Stock	$\frac{11}{16}'' \times 6\text{-}9/16'' \times 10'$	<b>H</b>	59
LHVG10712 (1609866)	Flat Stock	$\frac{11}{16}'' \times 6\text{-}9/16'' \times 12'$	<b>H</b>	59
LHVG1075 (1011152)	Flat Stock	$\frac{11}{16}'' \times 6\text{-}9/16'' \times \text{RL}$	<b>H</b>	59
LHVG108 (1625891)	Flat Stock	$\frac{11}{16}'' \times 7\text{-}1/4'' \times \text{RL}$	<b>H</b>	59
LHVG10808 (1007732)	Flat Stock	$\frac{11}{16}'' \times 7\text{-}1/4'' \times 8'$	<b>H</b>	59
LHVG10810 (1004526)	Flat Stock	$\frac{11}{16}'' \times 7\text{-}1/4'' \times 10'$	<b>H</b>	59
LHVG10812 (1555618)	Flat Stock	$\frac{11}{16}'' \times 7\text{-}1/4'' \times 12'$	<b>H</b>	59
LHVG1085 (1011007)	Flat Stock	$\frac{11}{16}'' \times 7\text{-}1/4'' \times \text{RL}$	<b>H</b>	59
LHVG110 (1555619)	Flat Stock	$\frac{11}{16}'' \times 9\text{-}1/4'' \times \text{RL}$	<b>H</b>	59
LHVG112 (1555620)	Flat Stock	$\frac{11}{16}'' \times 11\text{-}1/4'' \times \text{RL}$	<b>H</b>	59
LHVG202 (1555621)	Flat Stock	$1\text{-}1/2'' \times 1\text{-}1/2'' \times \text{RL}$	<b>H</b>	59
LHVG204 (1010062)	Flat Stock	$1\text{-}1/2'' \times 3\text{-}1/2'' \times \text{RL}$	<b>H</b>	59
LHVG206 (1011095)	Flat Stock	$1\text{-}1/2'' \times 5\text{-}1/2'' \times \text{RL}$	<b>H</b>	59
LHVG208 (1005716)	Flat Stock	$1\text{-}1/2'' \times 7\text{-}1/4'' \times \text{RL}$	<b>H</b>	59
LHV544 (1008290)	Flat Stock	$1'' \times 3\text{-}1/2'' \times \text{RL}$	<b>H</b>	59
LHV545 (1007968)	Flat Stock	$1'' \times 4\text{-}1/2'' \times \text{RL}$	<b>H</b>	59
LHV546 (1002280)	Flat Stock	$1'' \times 5\text{-}1/2'' \times \text{RL}$	<b>H</b>	59
LHV548 (1006688)	Flat Stock	$1'' \times 7\text{-}1/4'' \times \text{RL}$	<b>H</b>	59
LMP102 (1328077)	Flat Stock	$\frac{3}{4}'' \times 1\text{-}1/2'' \times \text{RL}$	<b>MAP</b>	59
LMP104 (1328085)	Flat Stock	$\frac{3}{4}'' \times 3\text{-}1/2'' \times \text{RL}$	<b>MAP</b>	59
LMP106 (1328090)	Flat Stock	$\frac{3}{4}'' \times 5\text{-}1/2'' \times \text{RL}$	<b>MAP</b>	59
LPOP1/04 (1609894)	Flat Stock	$\frac{1}{2}'' \times 3\text{-}1/2'' \times \text{RL}$	<b>POP</b>	59
LPOP1/06 (1609895)	Flat Stock	$\frac{1}{2}'' \times 5\text{-}1/2'' \times \text{RL}$	<b>POP</b>	59
LPOP102 (1625928)	Flat Stock	$\frac{3}{4}'' \times 1\text{-}1/2'' \times \text{RL}$	<b>POP</b>	59
LPOP10210 (1002101)	Flat Stock	$\frac{3}{4}'' \times 1\text{-}1/2'' \times 10'$	<b>POP</b>	59
LPOP103 (1625929)	Flat Stock	$\frac{23}{32}'' \times 2\text{-}1/2'' \times \text{RL}$	<b>POP</b>	59
LPOP104 (1625930)	Flat Stock	$\frac{3}{4}'' \times 3\text{-}1/2'' \times \text{RL}$	<b>POP</b>	59
LPOP105 (1625931)	Flat Stock	$\frac{11}{16}'' \times 4\text{-}9/16'' \times \text{RL}$	<b>POP</b>	59
LPOP106 (1625932)	Flat Stock	$\frac{23}{32}'' \times 5\text{-}1/2'' \times \text{RL}$	<b>POP</b>	59
LPOP108 (1625933)	Flat Stock	$\frac{23}{32}'' \times 7\text{-}1/4'' \times \text{RL}$	<b>POP</b>	59
LPOP110 (1484185)	Flat Stock	$\frac{3}{4}'' \times 9\text{-}1/4'' \times \text{RL}$	<b>POP</b>	59
LPOP112 (1484231)	Flat Stock	$\frac{3}{4}'' \times 11\text{-}1/4'' \times \text{RL}$	<b>POP</b>	59
LPOP546 (1609908)	Flat Stock	$1\text{-}1/16'' \times 5\text{-}1/2'' \times \text{RL}$	<b>POP</b>	59
LPOP548 (1609909)	Flat Stock	$1\text{-}1/16'' \times 7\text{-}1/4'' \times \text{RL}$	<b>POP</b>	59
LRO102 (1328165)	Flat Stock	$\frac{3}{4}'' \times 1\text{-}1/2'' \times \text{RL}$	<b>O</b>	59

Stock Code	Profile Type	Dimensions	Species	Page
LRO103 (1328170)	Flat Stock	$\frac{3}{4}'' \times 2\text{-}1/2'' \times \text{RL}$	<b>O</b>	59
LRO104 (1328175)	Flat Stock	$\frac{3}{4}'' \times 3\text{-}1/2'' \times \text{RL}$	<b>O</b>	59
LRO105 (1328180)	Flat Stock	$\frac{3}{4}'' \times 4\text{-}1/2'' \times \text{RL}$	<b>O</b>	59
LRO106 (1328185)	Flat Stock	$\frac{3}{4}'' \times 5\text{-}1/2'' \times \text{RL}$	<b>O</b>	59
LRO108 (1625967)	Flat Stock	$\frac{3}{4}'' \times 7\text{-}1/4'' \times \text{RL}$	<b>O</b>	59
MACH102 (1609928)	Flat Stock	$\frac{11}{16}'' \times 1\text{-}1/2'' \times 14'$	<b>MPH</b>	59
MACH104 (1609931)	Flat Stock	$\frac{11}{16}'' \times 3\text{-}1/2'' \times 14'$	<b>MPH</b>	59
MACH105 (1609932)	Flat Stock	$\frac{11}{16}'' \times 4\text{-}9/16'' \times 14'$	<b>MPH</b>	59
MACH106 (1609933)	Flat Stock	$\frac{11}{16}'' \times 5\text{-}1/2'' \times 14'$	<b>MPH</b>	59
MACH107 (1609934)	Flat Stock	$\frac{11}{16}'' \times 6\text{-}9/16'' \times 14'$	<b>MPH</b>	59
MACH108 (1609935)	Flat Stock	$\frac{11}{16}'' \times 7\text{-}1/4'' \times 14'$	<b>MPH</b>	59
MACH110 (1609936)	Flat Stock	$\frac{11}{16}'' \times 9\text{-}1/4'' \times 14'$	<b>MPH</b>	59
MACH473 (1609939)	Casing	$\frac{1}{2}'' \times 2\text{-}1/4'' \times 14'$	<b>MPH</b>	36
MACH573 (1609941)	Baseboard	$\frac{3}{8}'' \times 3\text{-}1/4'' \times 14'$	<b>MPH</b>	20
MACH593 (1609942)	Door Stop	$\frac{7}{16}'' \times 1\text{-}1/16'' \times 14'$	<b>MPH</b>	57
MAK103B0 (1555675)	Casing	$\frac{3}{4}'' \times 2\text{-}1/2'' \times \text{RL}$	<b>ALD</b>	36
MAK103B008 (1668157)	Casing	$\frac{3}{4}'' \times 2\text{-}1/2'' \times 8'$	<b>ALD</b>	36
MAK104B0 (1555676)	Casing	$\frac{3}{4}'' \times 3\text{-}1/2'' \times \text{RL}$	<b>ALD</b>	37
MAK104B008 (1050664)	Casing	$\frac{3}{4}'' \times 3\text{-}1/2'' \times 8'$	<b>ALD</b>	37
MAK3111 (1010058)	Baseboard	$\frac{1}{2}'' \times 3\text{-}1/4'' \times \text{RL}$	<b>ALD</b>	20
MAK3112 (1555678)	Baseboard	$\frac{1}{2}'' \times 3\text{-}1/2'' \times \text{RL}$	<b>ALD</b>	20
MAK342208 (1004943)	Door Stop	$\frac{3}{8}'' \times 1\text{-}3/16'' \times 8'$	<b>ALD</b>	56
MAK356WM (1050667)	Casing	$\frac{3}{4}'' \times 2\text{-}1/4'' \times \text{RL}$	<b>ALD</b>	29
MAK413 (1007674)	Casing	$\frac{3}{4}'' \times 3\text{-}1/4'' \times \text{RL}$	<b>ALD</b>	37
MAK41308 (1009582)	Casing	$\frac{3}{4}'' \times 3\text{-}1/4'' \times 8'$	<b>ALD</b>	37
MAK585B0 (1050670)	Baseboard	$\frac{5}{8}'' \times 5'' \times \text{RL}$	<b>ALD</b>	21
MAK585B010 (1681611)	Baseboard	$\frac{5}{8}'' \times 5'' \times 10'$	<b>ALD</b>	21
MAK603 (1009884)	Baseboard	$\frac{5}{8}'' \times 5\text{-}1/4'' \times \text{RL}$	<b>ALD</b>	21
MAK618 (1008069)	Baseboard	$\frac{1}{2}'' \times 5\text{-}1/4'' \times \text{RL}$	<b>ALD</b>	15
MAK623 (1006737)	Baseboard	$\frac{9}{16}'' \times 3\text{-}1/4'' \times \text{RL}$	<b>ALD</b>	14
MAK867CDAF07 (1609985)	Door Stop	$\frac{1}{2}'' \times 1\text{-}1/4'' \times 7'$	<b>ALD</b>	56
MAK87608 (1004214)	Door Stop	$\frac{1}{2}'' \times 1\text{-}1/2'' \times 8'$	<b>ALD</b>	56
MAK9532 (1008384)	Sash Bead	$\frac{1}{2}'' \times 1\text{-}1/4'' \times \text{RL}$	<b>ALD</b>	61
MAKJ458C99 (1065207)	Jamb	$1\text{-}3/16'' \times 4\text{-}5/8'' \times 98''$	<b>ALD</b>	63
MAKJ458F9712 (1009803)	Jamb	$\frac{3}{4}'' \times 4\text{-}5/8'' \times 100''$	<b>ALD</b>	63
MAKJ478F86 (1609996)	Jamb	$\frac{3}{4}'' \times 4\text{-}7/8'' \times 86''$	<b>ALD</b>	63
MAKJ49F (1555689)	Jamb	$\frac{3}{4}'' \times 4\text{-}9/16'' \times 82\text{-}1/4''$	<b>ALD</b>	63
MAKJ658F-S09 (1555691)	Jamb	$\frac{3}{4}'' \times 6\text{-}5/8'' \times 81\text{-}11/16''$	<b>ALD</b>	63
MAKJ658F9712 (1566843)	Jamb	$\frac{3}{4}'' \times 6\text{-}5/8'' \times 98\text{-}3/16''$	<b>ALD</b>	63
MAKJ69FX (1009977)	Jamb	$\frac{3}{4}'' \times 6\text{-}9/16'' \times 84''$	<b>ALD</b>	63
MAKRB6 (1009179)	Architrave	$1\text{-}1/4'' \times 4\text{-}3/16'' \times \text{RL}$	<b>ALD</b>	6
MASC102 (1610038)	Flat Stock	$\frac{21}{32}'' \times 1\text{-}3/8'' \times 14'$	<b>PCH</b>	59
MASC104 (1610039)	Flat Stock	$\frac{21}{32}'' \times 3\text{-}1/2'' \times 14'$	<b>PCH</b>	59
MASC105 (1555695)	Flat Stock	$\frac{5}{8}'' \times 4\text{-}9/16'' \times 14'$	<b>PCH</b>	59
MASC106 (1007311)	Flat Stock	$\frac{5}{8}'' \times 5\text{-}1/2'' \times 14'$	<b>PCH</b>	59
MASC107 (1009165)	Flat Stock	$\frac{21}{32}'' \times 6\text{-}9/16'' \times 14'$	<b>PCH</b>	59
MASC108 (1610043)	Flat Stock	$\frac{21}{32}'' \times 7\text{-}1/4'' \times 14'$	<b>PCH</b>	59
MASC110 (1610044)	Flat Stock	$\frac{11}{16}'' \times 9\text{-}1/4'' \times 14'$	<b>PCH</b>	59
MASC473 (1011389)	Casing	$\frac{1}{2}'' \times 2\text{-}1/4'' \times 14'$	<b>PCH</b>	36
MASC573 (1610046)	Baseboard	$\frac{3}{8}'' \times 3\text{-}1/4'' \times 14'$	<b>PCH</b>	20
MAUF102 (1610078)	Flat Stock	$\frac{11}{16}'' \times 1\text{-}1/2'' \times 14'$	<b>MUF</b>	59
MAUF104 (1610079)	Flat Stock	$\frac{11}{16}'' \times 3\text{-}1/2'' \times 14'$	<b>MUF</b>	59
MAUF105 (1610080)	Flat Stock	$\frac{11}{16}'' \times 4\text{-}9/16'' \times 14'$	<b>MUF</b>	59
MAUF106 (1610081)	Flat Stock	$\frac{11}{16}'' \times 5\text{-}1/2'' \times 14'$	<b>MUF</b>	59

# INDEX

Stock Code	Profile Type	Dimensions	Species	Page
MAUF107 (1610082)	Flat Stock	$11/16'' \times 6-9/16'' \times 14'$	MUF	59
MAUF108 (1610083)	Flat Stock	$11/16'' \times 7-1/4'' \times 14'$	MUF	59
MAUF110 (1039384)	Flat Stock	$11/16'' \times 9-1/4'' \times 14'$	MUF	59
MAUF473 (1610086)	Casing	$1/2'' \times 2-1/4'' \times 14'$	MUF	36
MAUF573 (1610088)	Baseboard	$11/32'' \times 3-1/4'' \times \text{RL}$	MAF	20
MEAON102 (1555714)	Flat Stock	$21/32'' \times 1-3/8'' \times 14'$	PAO	59
MEAON104 (1006601)	Flat Stock	$21/32'' \times 3-1/2'' \times 14'$	PAO	59
MEAON105 (1010978)	Flat Stock	$21/32'' \times 4-9/16'' \times 14'$	PAO	59
MEAON106 (1006811)	Flat Stock	$21/32'' \times 5-1/2'' \times 14'$	PAO	59
MEAON107 (1009185)	Flat Stock	$21/32'' \times 6-9/16'' \times 14'$	PAO	59
MEAON108 (1005712)	Flat Stock	$21/32'' \times 7-1/4'' \times 14'$	PAO	59
MEAON110 (1006997)	Flat Stock	$21/32'' \times 9-1/4'' \times 14'$	PAO	59
MEAON3000 (1555721)	Casing	$7/16'' \times 1-7/16'' \times 14'$	PAO	27
MEAON3002 (1006192)	Casing	$7/16'' \times 2-1/4'' \times 14'$	PAO	27
MEAON356 (1555723)	Casing	$7/16'' \times 2-7/32'' \times 14'$	PAO	29
MEAONJ413FSA (1003615)	Jamb	$1-1/8'' \times 4-13/16'' \times 7'$	PAO	63
MEAONJ49FSA (1009332)	Jamb	$1-1/16'' \times 4-9/16'' \times 7'$	PAO	63
MECH356 (1610135)	Casing	$7/16'' \times 2-7/32'' \times 14'$	PEH	29
MECH624 (1610139)	Baseboard	$5/16'' \times 2-3/4'' \times 14'$	PEH	14
MECHJ413FSA (1039441)	Jamb	$1-1/8'' \times 4-13/16'' \times 81-5/8''$	PEH	63
MECHJ49FSA (1039934)	Jamb	$1-1/8'' \times 4-9/16'' \times 81-5/8''$	PEH	63
MECHJ613KS (1039446)	Jamb	$1-3/16'' \times 6-13/16'' \times 7'$	PEH	63
MEDO356 (1555733)	Casing	$7/16'' \times 2-7/32'' \times 14'$	PDO	29
MEGON102 (1003290)	Flat Stock	$21/32'' \times 1-3/8'' \times 14'$	PGO	60
MEGON104 (1004315)	Flat Stock	$21/32'' \times 3-1/2'' \times 14'$	PGO	60
MEGON105 (1009965)	Flat Stock	$5/8'' \times 4-9/16'' \times 14'$	PGO	60
MEGON106 (1009010)	Flat Stock	$21/32'' \times 5-1/2'' \times 14'$	PGO	60
MEGON107 (1007575)	Flat Stock	$21/32'' \times 6-9/16'' \times 14'$	PGO	60
MEGON108 (1006844)	Flat Stock	$21/32'' \times 7-1/4'' \times 14'$	PGO	60
MEGON110 (1010519)	Flat Stock	$11/16'' \times 9-1/4'' \times 14'$	PGO	60
MEGON3000 (1555741)	Casing	$7/16'' \times 1-7/16'' \times 14'$	PGO	27
MEGON3002 (1002393)	Casing	$7/16'' \times 2-1/4'' \times 14'$	PGO	27
MEGON342207 (1610161)	Door Stop	$5/16'' \times 1-1/4'' \times 7'$	PGO	56
MEGON356 (1008298)	Casing	$7/16'' \times 2-7/32'' \times 14'$	PGO	29
MEGONJ413FSA (1005648)	Jamb	$1-1/8'' \times 4-13/16'' \times 7'$	PGO	63
MEGONJ49F (1009251)	Jamb	$11/16'' \times 4-9/16'' \times 7'$	PGO	63
MEGONJ49FSA (1008361)	Jamb	$1-1/16'' \times 4-9/16'' \times 7'$	PGO	63
MEGONJ613KS (1555750)	Jamb	$1-3/16'' \times 6-13/16'' \times 7'$	PGO	63
MESAJ49FSA (1555774)	Jamb	$1-1/16'' \times 4-9/16'' \times 7'$	PEA	63
MESAN356 (1610198)	Casing	$7/16'' \times 2-7/32'' \times 14'$	PEA	29
MESC356 (1555777)	Casing	$7/16'' \times 2-7/32'' \times 14'$	PCH	29
MESCJ413FSA (1555782)	Jamb	$1-1/8'' \times 4-13/16'' \times 7'$	CHR	63
MESCJ49FSA (1555785)	Jamb	$1-1/16'' \times 4-9/16'' \times 7'$	PCH	63
MESCJ613KS (1555787)	Jamb	$1-3/16'' \times 6-13/16'' \times 7'$	PCH	63
MESM102 (1006392)	Flat Stock	$21/32'' \times 1-3/8'' \times 14'$	PEM	60
MESM104 (1010863)	Flat Stock	$21/32'' \times 3-1/2'' \times 14'$	PEM	60
MESM105 (1002287)	Flat Stock	$21/32'' \times 4-9/16'' \times 14'$	PEM	60
MESM106 (1007756)	Flat Stock	$21/32'' \times 5-1/2'' \times 14'$	PEM	60
MESM107 (1003679)	Flat Stock	$21/32'' \times 6-9/16'' \times 14'$	PEM	60
MESM108 (1006749)	Flat Stock	$21/32'' \times 7-1/4'' \times 14'$	PEM	60
MESM110 (1002728)	Flat Stock	$21/32'' \times 9-1/4'' \times 14'$	PEM	60
MESM356 (1007805)	Casing	$7/16'' \times 2-7/32'' \times 14'$	PEM	29
MESMJ413FSA (1002812)	Jamb	$1-1/8'' \times 4-13/16'' \times 7'$	PEM	63
MESMJ49FSA (1007683)	Jamb	$1-1/16'' \times 4-9/16'' \times 7'$	PEM	63

Stock Code	Profile Type	Dimensions	Species	Page
MESMJ613KS (1007638)	Jamb	$1-3/16'' \times 6-13/16'' \times 83-1/2''$	PEM	63
MEUF356 (1610265)	Casing	$7/16'' \times 2-7/32'' \times 14'$	MUF	29
MEUFJ413FSA (1039940)	Jamb	$1-1/8'' \times 4-13/16'' \times 81-5/8''$	MUF	63
MEUFJ49FSA (1039935)	Jamb	$1-1/8'' \times 4-9/16'' \times 81-5/8''$	MUF	63
MEUFJ613KS (1610273)	Jamb	$1-3/16'' \times 6-13/16'' \times 7'$	MUF	63
MFP003 (1555819)	Casing	$11/16'' \times 3-1/4'' \times 16'$	MDF/UL	34
MFP019 (1555820)	Casing	$9/16'' \times 2-1/4'' \times 16'$	MDF/UL	33
MFP01907 (1555821)	Casing	$9/16'' \times 2-1/4'' \times 7'$	MDF/UL	33
MFP029 (1555822)	Baseboard	$9/16'' \times 5-1/4'' \times 16'$	MDF/UL	23
MFP040 (1328500)	Crown	$11/16'' \times 4-1/4'' \times 16'$	MDF/UL	48
MFP041 (1626152)	Crown	$1-3/16'' \times 6-5/16'' \times 16'$	MDF/UL	48
MFP043 (1555825)	Crown	$1'' \times 6-15/16'' \times 16'$	MDF/UL	54
MFP045 (1448078)	Crown	$9/16'' \times 5-1/4'' \times 16'$	MDF/UL	47
MFP045T (1394528)	Crown	$9/16'' \times 5-3/16'' \times 16'$	MDF/UL	47
MFP047 (1626166)	Crown	$5/8'' \times 4-1/4'' \times 16'$	MDF/UL	46
MFP051 (1555828)	Crown	$9/16'' \times 3-1/4'' \times 16'$	MDF/UL	47
MFP054 (1555829)	Crown	$9/16'' \times 2-1/4'' \times 16'$	MDF/UL	46
MFP092 (1555830)	Casing	$5/8'' \times 2-1/2'' \times 16'$	MDF/UL	30
MFP09207 (1555831)	Casing	$5/8'' \times 2-1/2'' \times 7'$	MDF/UL	30
MFP093 (1555832)	Casing	$5/8'' \times 3-1/4'' \times 16'$	MDF/UL	32
MFP094 (1555833)	Baseboard	$9/16'' \times 4'' \times 16'$	MDF/UL	16
MFP095 (1064044)	Baseboard	$9/16'' \times 5'' \times 16'$	MDF/UL	17
MFP106 (1555835)	Flat Stock	$1/2'' \times 3-1/2'' \times 16'$	MDF/UL	60
MFP105 (1555836)	Flat Stock	$1/2'' \times 4-1/2'' \times 16'$	MDF/UL	60
MFP106 (1555837)	Flat Stock	$1/2'' \times 5-1/2'' \times 16'$	MDF/UL	60
MFP108 (1555838)	Flat Stock	$1/2'' \times 7-1/4'' \times 16'$	MDF/UL	60
MFP102 (1626102)	Flat Stock	$11/16'' \times 1-1/2'' \times 16'$	MDF/UL	60
MFP10208 (1328228)	Flat Stock	$11/16'' \times 1-1/2'' \times 8'$	MDF/UL	60
MFP10210 (1555841)	Flat Stock	$11/16'' \times 1-1/2'' \times 10'$	MDF/UL	60
MFP10212 (1626016)	Flat Stock	$11/16'' \times 1-1/2'' \times 12'$	MDF/UL	60
MFP103 (1566872)	Flat Stock	$11/16'' \times 2-1/2'' \times 16'$	MDF/UL	60
MFP10308 (1328231)	Flat Stock	$11/16'' \times 2-1/2'' \times 8'$	MDF/UL	60
MFP10310 (1555845)	Flat Stock	$11/16'' \times 2-1/2'' \times 10'$	MDF/UL	60
MFP10312 (1328232)	Flat Stock	$11/16'' \times 2-1/2'' \times 12'$	MDF/UL	60
MFP10385B0 (1610320)	Casing	$11/16'' \times 2-1/2'' \times 85'$	MDF/UL	36
MFP104 (1555846)	Flat Stock	$11/16'' \times 3-1/2'' \times 16'$	MDF/UL	60
MFP10408 (1328234)	Flat Stock	$11/16'' \times 3-1/2'' \times 8'$	MDF/UL	60
MFP10410 (1367570)	Flat Stock	$11/16'' \times 3-1/2'' \times 10'$	MDF/UL	60
MFP10412 (1328236)	Flat Stock	$11/16'' \times 3-1/2'' \times 12'$	MDF/UL	60
MFP105 (1555850)	Flat Stock	$11/16'' \times 4-9/16'' \times 16'$	MDF/UL	60
MFP10508 (1328239)	Flat Stock	$11/16'' \times 4-9/16'' \times 8'$	MDF/UL	60
MFP10510 (1610328)	Flat Stock	$11/16'' \times 4-9/16'' \times 10'$	MDF/UL	60
MFP10512 (1328241)	Flat Stock	$11/16'' \times 4-9/16'' \times 12'$	MDF/UL	60
MFP106 (1555852)	Flat Stock	$11/16'' \times 5-1/2'' \times 16'$	MDF/UL	60
MFP10608 (1328245)	Flat Stock	$11/16'' \times 5-1/2'' \times 8'$	MDF/UL	60
MFP10610 (1555854)	Flat Stock	$11/16'' \times 5-1/2'' \times 10'$	MDF/UL	60
MFP10612 (1428878)	Flat Stock	$11/16'' \times 5-1/2'' \times 12'$	MDF/UL	60
MFP107 (1555856)	Flat Stock	$11/16'' \times 6-9/16'' \times 16'$	MDF/UL	60
MFP108 (1555857)	Flat Stock	$11/16'' \times 7-1/4'' \times 16'$	MDF/UL	60
MFP10808 (1555858)	Flat Stock	$11/16'' \times 7-1/4'' \times 8'$	MDF/UL	60
MFP10810 (1006533)	Flat Stock	$11/16'' \times 7-1/4'' \times 10'$	MDF/UL	60
MFP10812 (1328251)	Flat Stock	$11/16'' \times 7-1/4'' \times 12'$	MDF/UL	60
MFP110 (1555861)	Flat Stock	$11/16'' \times 9-1/4'' \times 16'$	MDF/UL	60
MFP11008 (1555862)	Flat Stock	$11/16'' \times 9-1/4'' \times 8'$	MDF/UL	60

# INDEX

Stock Code	Profile Type	Dimensions	Species	Page
MFP11010 (1555863)	Flat Stock	$\frac{11}{16}'' \times 9\text{--}\frac{1}{4}'' \times 10'$	MDF/UL	60
MFP112 (1555864)	Flat Stock	$\frac{11}{16}'' \times 11\text{--}\frac{1}{4}'' \times 16'$	MDF/UL	60
MFP11208 (1328252)	Flat Stock	$\frac{3}{4}'' \times 11\text{--}\frac{1}{4}'' \times 8'$	MDF/UL	60
MFP11210 (1555866)	Flat Stock	$\frac{11}{16}'' \times 11\text{--}\frac{1}{4}'' \times 10'$	MDF/UL	60
MFP11212 (1555867)	Flat Stock	$\frac{11}{16}'' \times 11\text{--}\frac{1}{4}'' \times 12'$	MDF/UL	60
MFP161 (1555868)	Baseboard	$\frac{9}{16}'' \times 5\text{--}\frac{1}{4}'' \times 16'$	MDF/UL	18
MFP163 (1555869)	Baseboard	$\frac{9}{16}'' \times 7\text{--}\frac{1}{4}'' \times 16'$	MDF/UL	18
MFP206 (1509989)	Baseboard	$\frac{9}{16}'' \times 5\text{--}\frac{1}{4}'' \times 16'$	MDF/UL	17
MFP207 (1002010)	Baseboard	$\frac{9}{16}'' \times 7\text{--}\frac{1}{4}'' \times 16'$	MDF/UL	19
MFP222 (1002119)	Wainscot	$\frac{3}{8}'' \times 5\text{--}\frac{3}{4}'' \times 10'$	MDF/UL	73
MFP297 (1555876)	Chair Rail	$\frac{11}{16}'' \times 3'' \times 16'$	MDF/UL	42
MFP3000 (1555877)	Casing	$\frac{1}{2}'' \times 1\text{--}\frac{5}{8}'' \times 16'$	MDF/UL	27
MFP300007 (1555878)	Casing	$\frac{1}{2}'' \times 1\text{--}\frac{5}{8}'' \times 7'$	MDF/UL	27
MFP3002 (1050329)	Casing	$\frac{9}{16}'' \times 2\text{--}\frac{1}{4}'' \times 16'$	MDF/UL	27
MFP300207 (1555880)	Casing	$\frac{9}{16}'' \times 2\text{--}\frac{1}{4}'' \times 7'$	MDF/UL	27
MFP310 (1555882)	Baseboard	$\frac{1}{2}'' \times 4\text{--}\frac{1}{8}'' \times 16'$	MDF/UL	16
MFP3112 (1009326)	Baseboard	$\frac{1}{2}'' \times 3\text{--}\frac{1}{4}'' \times 16'$	MDF/UL	20
MFP3122 (1555886)	Casing	$1'' \times 3\text{--}\frac{1}{2}'' \times 16'$	MDF/UL	28
MFP3140 (1328267)	Baseboard	$\frac{3}{8}'' \times 3\text{--}\frac{1}{4}'' \times 14'$	MDF/UL	13
MFP340 (1555890)	Casing	$\frac{9}{16}'' \times 3\text{--}\frac{1}{8}'' \times 14'$	MDF/UL	41
MFP346 (1566915)	Casing	$\frac{9}{16}'' \times 2\text{--}\frac{1}{4}'' \times 17'$	MDF/UL	32
MFP350 (1555891)	Casing	$\frac{9}{16}'' \times 2\text{--}\frac{1}{4}'' \times 16'$	MDF/UL	31
MFP356 (1555892)	Casing	$\frac{9}{16}'' \times 2\text{--}\frac{1}{4}'' \times 16'$	MDF/UL	29
MFP35610 (1555893)	Casing	$\frac{9}{16}'' \times 2\text{--}\frac{1}{4}'' \times 10'$	MDF/UL	29
MFP35617 (1555894)	Casing	$\frac{9}{16}'' \times 2\text{--}\frac{1}{4}'' \times 17'$	MDF/UL	29
MFP35685 (1555895)	Casing	$\frac{9}{16}'' \times 2\text{--}\frac{1}{4}'' \times 85''$	MDF/UL	29
MFP409 (1626151)	Chair Rail	$1\text{--}\frac{3}{16}'' \times 1\text{--}\frac{7}{8}'' \times 14'$	MDF/UL	42
MFP410U (1566938)	Casing	$\frac{11}{16}'' \times 2\text{--}\frac{1}{4}'' \times 14'$	MDF/UL	30
MFP411U (1626154)	Casing	$\frac{11}{16}'' \times 3'' \times 15'$	MDF/UL	32
MFP412U (1328503)	Baseboard	$\frac{9}{16}'' \times 4\text{--}\frac{1}{4}'' \times 16'$	MDF/UL	16
MFP413 (1003499)	Flat Stock	$\frac{11}{16}'' \times 4\text{--}\frac{19}{16}'' \times 16'$	MDF/UL	60
MFP414U (1566948)	Baseboard	$\frac{9}{16}'' \times 5\text{--}\frac{1}{4}'' \times 16'$	MDF/UL	15
MFP443 (1010582)	Crown	$1'' \times 3\text{--}\frac{9}{16}'' \times 16'$	MDF/UL	49
MFP444U (1555905)	Baseboard	$\frac{9}{16}'' \times 3\text{--}\frac{1}{8}'' \times 16'$	MDF/UL	13
MFP472 (1328373)	Casing	$\frac{9}{16}'' \times 2\text{--}\frac{1}{2}'' \times 14'$	MDF/UL	35
MFP473 (1555907)	Casing	$\frac{9}{16}'' \times 2\text{--}\frac{1}{4}'' \times 16'$	MDF/UL	36
MFP47307 (1555908)	Casing	$\frac{9}{16}'' \times 2\text{--}\frac{1}{4}'' \times 7'$	MDF/UL	36
MFP492 (1555909)	Casing	$\frac{1}{2}'' \times 2\text{--}\frac{1}{2}'' \times 14'$	MDF/UL	35
MFP494 (1555910)	Casing	$\frac{1}{2}'' \times 3\text{--}\frac{1}{4}'' \times 16'$	MDF/UL	35
MFP49408 (1566956)	Casing	$\frac{1}{2}'' \times 3\text{--}\frac{1}{4}'' \times 8'$	MDF/UL	35
MFP495 (1555911)	Casing	$\frac{11}{16}'' \times 3\text{--}\frac{1}{2}'' \times 16'$	MDF/UL	37
MFP49507 (1545341)	Casing	$\frac{11}{16}'' \times 3\text{--}\frac{1}{2}'' \times 7'$	MDF/UL	37
MFP $\frac{9}{44}$ (1555913)	Flat Stock	$1'' \times 3\text{--}\frac{1}{2}'' \times 16'$	MDF/UL	60
MFP $\frac{9}{45}$ (1555914)	Flat Stock	$1'' \times 4\text{--}\frac{9}{16}'' \times 16'$	MDF/UL	60
MFP $\frac{9}{46}$ (1545343)	Flat Stock	$1'' \times 5\text{--}\frac{1}{2}'' \times 16'$	MDF/UL	60
MFP $\frac{9}{48}$ (1555916)	Flat Stock	$1'' \times 7\text{--}\frac{1}{4}'' \times 16'$	MDF/UL	60
MFP5000 (1341811)	Architrave	$1\text{--}\frac{3}{16}'' \times 3\text{--}\frac{3}{4}'' \times 16'$	MDF/UL	6
MFP5010 (1626186)	Architrave	$1\text{--}\frac{3}{16}'' \times 4\text{--}\frac{1}{4}'' \times 16'$	MDF/UL	8
MFP5020 (1610429)	Architrave	$1\text{--}\frac{3}{16}'' \times 5\text{--}\frac{1}{4}'' \times \text{RL}$	MDF/UL	8
MFP5030 (1328518)	Architrave	$1\text{--}\frac{3}{16}'' \times 6\text{--}\frac{1}{4}'' \times 16'$	MDF/UL	8
MFP535 (1610431)	Casing	$\frac{9}{16}'' \times 3\text{--}\frac{1}{2}'' \times 16'$	MDF/UL	37
MFP545 (1341818)	Baseboard	$\frac{9}{16}'' \times 5'' \times 16'$	MDF/UL	19
MFP618 (1328523)	Baseboard	$\frac{1}{2}'' \times 5\text{--}\frac{1}{4}'' \times 16'$	MDF/UL	15
MFP623 (1566985)	Baseboard	$\frac{1}{2}'' \times 3\text{--}\frac{1}{4}'' \times 16'$	MDF/UL	14

Stock Code	Profile Type	Dimensions	Species	Page
MFP62312 (1555930)	Baseboard	$\frac{1}{2}'' \times 3\text{--}\frac{1}{4}'' \times 12'$	MDF/UL	14
MFP624 (1610440)	Baseboard	$\frac{1}{2}'' \times 4\text{--}\frac{1}{4}'' \times 16'$	MDF/UL	15
MFP625 (1555931)	Baseboard	$\frac{1}{2}'' \times 2\text{--}\frac{1}{4}'' \times 16'$	MDF/UL	14
MFP635 (1555933)	Baseboard	$\frac{9}{16}'' \times 5\text{--}\frac{5}{8}'' \times 16'$	MDF/UL	15
MFP712 (1555934)	Crown	$\frac{11}{16}'' \times 4\text{--}\frac{1}{2}'' \times 16'$	MDF/UL	55
MFP750H (1555935)	Casing	$\frac{5}{8}'' \times 5\text{--}\frac{1}{4}'' \times 16'$	MDF/UL	40
MFP754H (1567003)	Casing	$\frac{11}{16}'' \times 3\text{--}\frac{1}{4}'' \times 16'$	MDF/UL	40
MFP8063 (1448090)	Casing	$\frac{11}{16}'' \times 3\text{--}\frac{1}{4}'' \times 16'$	MDF/UL	32
MFP8233 (1046142)	Casing	$\frac{9}{16}'' \times 3\text{--}\frac{1}{4}'' \times 16'$	MDF/UL	33
MFP8234 (1555938)	Baseboard	$\frac{9}{16}'' \times 5\text{--}\frac{1}{2}'' \times 16'$	MDF/UL	18
MFP8243 (1555939)	Baseboard	$\frac{1}{2}'' \times 4\text{--}\frac{1}{4}'' \times 16'$	MDF/UL	18
MFP8312 (1555941)	Baseboard	$\frac{1}{2}'' \times 4\text{--}\frac{1}{4}'' \times 16'$	MDF/UL	13
MFP850 (1626091)	Wainscot Cap	$1\text{--}\frac{1}{16}'' \times 1\text{--}\frac{3}{4}'' \times 8'$	MDF/UL	70
MFP8910 (1341835)	Baseboard	$\frac{3}{8}'' \times 3\text{--}\frac{7}{8}'' \times 16'$	MDF/UL	16
MFP907 (1328547)	Casing	$\frac{9}{16}'' \times 2\text{--}\frac{1}{4}'' \times 14'$	MDF/UL	41
MFP908 (1555945)	Casing	$\frac{9}{16}'' \times 3\text{--}\frac{1}{4}'' \times 14'$	MDF/UL	41
MFP953112 (1050366)	Sash Bead	$\frac{7}{16}'' \times 1\text{--}\frac{9}{16}'' \times 12'$	MDF/UL	61
MFP953212 (1555947)	Sash Bead	$\frac{7}{16}'' \times 1\text{--}\frac{1}{4}'' \times 12'$	MDF/UL	61
MFPJ413C (1555949)	Jamb	$1\text{--}\frac{1}{16}'' \times 4\text{--}\frac{19}{16}'' \times 7'$	MDF/UL	63
MFPJ49D (1555950)	Jamb	$1\text{--}\frac{1}{16}'' \times 4\text{--}\frac{9}{16}'' \times 7'$	MDF/UL	63
MFPJLSTOP (1050363)	Door Stop	$\frac{1}{2}'' \times 1\text{--}\frac{11}{16}'' \times 7'$	MDF/UL	57
MFPJ901 (1328544)	Crown	$1\text{--}\frac{3}{16}'' \times 6\text{--}\frac{3}{4}'' \times 16'$	MDF/UL	50
MFSP102 (1050386)	Flat Stock	$\frac{11}{16}'' \times 1\text{--}\frac{1}{2}'' \times 16'$	MDF/UL	60
MFSP103 (1610482)	Flat Stock	$\frac{11}{16}'' \times 2\text{--}\frac{1}{2}'' \times 14'$	MDF/UL	60
MFSP104 (1555951)	Flat Stock	$\frac{11}{16}'' \times 3\text{--}\frac{1}{2}'' \times 14'$	MDF/UL	60
MFSP105 (1050388)	Flat Stock	$\frac{11}{16}'' \times 4\text{--}\frac{9}{16}'' \times 16'$	MDF/UL	60
MFSP106 (1050389)	Flat Stock	$\frac{11}{16}'' \times 5\text{--}\frac{1}{2}'' \times 16'$	MDF/UL	60
MFSP107 (1555952)	Flat Stock	$\frac{11}{16}'' \times 6\text{--}\frac{9}{16}'' \times 16'$	MDF/UL	60
MFSP108 (1610494)	Flat Stock	$\frac{11}{16}'' \times 7\text{--}\frac{1}{4}'' \times 16'$	MDF/UL	60
MFSP112 (1610496)	Flat Stock	$\frac{11}{16}'' \times 11\text{--}\frac{1}{4}'' \times 16'$	MDF/UL	60
MFSP472 (1328569)	Casing	$\frac{9}{16}'' \times 2\text{--}\frac{1}{2}'' \times 16'$	MDF/UL	35
MFSP492 (1050402)	Casing	$\frac{1}{2}'' \times 2\text{--}\frac{1}{2}'' \times 16'$	MDF/UL	35
MFSP494 (1050405)	Casing	$\frac{1}{2}'' \times 3\text{--}\frac{1}{4}'' \times 16'$	MDF/UL	35
MFSP514 (1380952)	Baseboard	$\frac{1}{2}'' \times 5\text{--}\frac{1}{4}'' \times 16'$	MDF/UL	21
MFSPJ413C (1610514)	Jamb	$1\text{--}\frac{1}{16}'' \times 4\text{--}\frac{19}{16}'' \times 81\text{--}\frac{5}{8}''$	MDF/UL	63
MFTKTREAD06 (1610517)	Stair Tread	$1\text{--}\frac{1}{16}'' \times 11\text{--}\frac{1}{2}'' \times 6'$	FIR	73
MFTKTREAD08 (1610518)	Stair Tread	$1\text{--}\frac{1}{16}'' \times 11\text{--}\frac{1}{2}'' \times 8'$	FIR	73
MFVG180 (1626279)	Brick Mould	$1\text{--}\frac{3}{16}'' \times 1\text{--}\frac{15}{16}'' \times \text{RL}$	FIR	26
MFVG3112 (1002782)	Baseboard	$\frac{1}{2}'' \times 3\text{--}\frac{1}{4}'' \times \text{RL}$	FIR	20
MFVG3288 (1555957)	Baseboard Shoe	$\frac{7}{16}'' \times \frac{11}{16}'' \times \text{RL}$	FIR	72
MFVG338 (1555958)	Casing	$\frac{3}{4}'' \times 3\text{--}\frac{1}{2}'' \times \text{RL}$	FIR	37
MFVG33807 (1555959)	Casing	$\frac{3}{4}'' \times 3\text{--}\frac{1}{2}'' \times 7'$	FIR	37
MFVG33808 (1555960)	Casing	$\frac{3}{4}'' \times 3\text{--}\frac{1}{2}'' \times 8'$	FIR	37
MFVG356WM07 (1555962)	Casing	$\frac{5}{8}'' \times 2\text{--}\frac{1}{4}'' \times 7'$	FIR	29
MFVG472 (1010019)	Casing	$\frac{5}{8}'' \times 2\text{--}\frac{1}{2}'' \times \text{RL}$	FIR	35
MFVG47207 (1555964)	Casing	$\frac{5}{8}'' \times 2\text{--}\frac{1}{2}'' \times 7'$	FIR	35
MFVG473 (1555965)	Casing	$\frac{5}{8}'' \times 2\text{--}\frac{9}{32}'' \times \text{RL}$	FIR	36
MFVG623 (1555968)	Baseboard	$\frac{13}{32}'' \times 3\text{--}\frac{1}{4}'' \times \text{RL}$	FIR	14
MFVG9532 (1555969)	Sash Bead	$\frac{7}{16}'' \times 1\text{--}\frac{1}{4}'' \times \text{RL}$	FIR	61
MFVGJ49C (1555970)	Jamb	$1\text{--}\frac{3}{16}'' \times 4\text{--}\frac{9}{16}'' \times 81\text{--}\frac{5}{8}''$	FIR	63
MFVGJ49C80 (1555971)	Jamb	$1\text{--}\frac{3}{16}'' \times 4\text{--}\frac{9}{16}'' \times 98\text{--}\frac{1}{16}''$	FIR	63
MFVGJ69C (1610542)	Jamb	$1\text{--}\frac{3}{16}'' \times 6\text{--}\frac{9}{16}'' \times 81\text{--}\frac{5}{8}''$	FIR	63
MFVGJ69C80 (1610543)	Jamb	$1\text{--}\frac{3}{16}'' \times 6\text{--}\frac{9}{16}'' \times 97\text{--}\frac{5}{8}''$	FIR	63
MFVGJ69K (1555974)	Jamb	$1\text{--}\frac{3}{16}'' \times 6\text{--}\frac{9}{16}'' \times 83\text{--}\frac{1}{2}''$	FIR	63

# INDEX

Stock Code	Profile Type	Dimensions	Species	Page
MFVVGJ71KL80 (1555976)	Jamb	1-3/16" x 7-1/4" x 99-3/4"	FIR	63
MFVGTREAD (1610549)	Stair Tread	1" x 11-1/4" x RL	FIR	73
MH001 (1555978)	Casing	7/16" x 2-3/16" x RL	H	35
MH00107 (1555979)	Casing	7/16" x 2-3/16" x 7'	H	35
MH00108 (1328584)	Casing	7/16" x 2-3/16" x 8'	H	35
MH00110 (1555981)	Casing	7/16" x 2-3/16" x 10'	H	35
MH003 (1626324)	Casing	5/8" x 3-1/4" x RL	H	34
MH00308 (1555984)	Casing	5/8" x 3-1/4" x 8'	H	34
MH00408 (1555985)	Back Band	1-1/8" x 1-5/16" x 8'	H	11
MH005 (1610561)	Casing	3/4" x 3-7/16" x RL	H	28
MH00508 (1555986)	Casing	3/4" x 3-7/16" x 8'	H	28
MH01007 (1555987)	Casing	7/16" x 1-1/2" x 7'	H	36
MH01008 (1328586)	Casing	7/16" x 1-1/2" x 8'	H	36
MH01010 (1555989)	Casing	7/16" x 1-1/2" x 10'	H	36
MH01012 (1555990)	Casing	7/16" x 1-1/2" x 12'	H	36
MH019 (1555991)	Casing	9/16" x 2-1/4" x RL	H	33
MH01907 (1555992)	Casing	9/16" x 2-1/4" x 7'	H	33
MH01910 (1555994)	Casing	9/16" x 2-1/4" x 10'	H	33
MH022 (1555996)	Panel Mould	1/2" x 1" x RL	H	66
MH033 (1555997)	Casing	5/8" x 2-3/16" x RL	H	33
MH040 (1555999)	Crown	11/16" x 4-1/4" x RL	H	48
MH04108 (1556001)	Baseboard	7/16" x 2-1/4" x 8'	H	12
MH04110 (1556002)	Baseboard	7/16" x 2-1/4" x 10'	H	12
MH04112 (1556003)	Baseboard	7/16" x 2-1/4" x 12'	H	12
MH048 (1556004)	Crown	1/2" x 4-3/16" x RL	H	46
MH049 (1556005)	Crown	1/2" x 3-3/16" x RL	H	47
MH04910 (1556007)	Crown	1/2" x 3-3/16" x 10'	H	47
MH04912 (1556008)	Crown	1/2" x 3-3/16" x 12'	H	47
MH05408 (1556010)	Crown	7/16" x 2-1/4" x 8'	H	46
MH05412 (1556011)	Crown	7/16" x 2-1/4" x 12'	H	46
MH06812 (1009801)	Crown	1/2" x 1-5/8" x 12'	H	45
MH07512 (1556013)	Bed Mould	1/2" x 1-5/8" x 12'	H	71
MH100108 (1556014)	Casing	5/8" x 3-1/4" x 8'	H	41
MH1208 (1328587)	Casing	11/16" x 2-1/2" x RL	H	30
MH120807 (1556017)	Casing	11/16" x 2-1/2" x 7'	H	30
MH125 (1556021)	Casing	9/16" x 2-1/16" x RL	H	29
MH12507 (1556022)	Casing	9/16" x 2-1/16" x 7'	H	29
MH156 (1011098)	Casing	9/16" x 2-1/4" x RL	H	31
MH15607DS (1005414)	Casing	9/16" x 2-1/4" x 7'	H	31
MH165 (1556023)	Baseboard Cap	3/4" x 1-1/8" x RL	H	25
MH168 (1004558)	Crown	11/16" x 5-1/4" x RL	H	49
MH180 (1556025)	Brick Mould	1-3/16" x 1-5/16" x RL	H	26
MH18007 (1556026)	Brick Mould	1-3/16" x 1-5/16" x 7'	H	26
MH18412 (1556027)	Chair Rail	5/8" x 2-7/16" x 12'	H	42
MH20408 (1556029)	Corner Guard	1-1/4" x 1-1/4" x 8'	H	43
MH20410 (1556030)	Corner Guard	1-1/4" x 1-1/4" x 10'	H	43
MH215 (1556031)	Casing	5/8" x 3-7/16" x RL	H	34
MH231 (1556034)	Hand Rail	1-7/16" x 1-5/8" x RL	H	62
MH23108 (1588539)	Hand Rail	1-7/16" x 1-5/8" x 8'	H	62
MH23112 (1588540)	Hand Rail	1-7/16" x 1-5/8" x 12'	H	62
MH258 (1556036)	Casing	11/16" x 2-3/16" x RL	H	28
MH25807 (1556037)	Casing	11/16" x 2-3/16" x 7'	H	28
MH26408 (1556038)	Lattice	1/4" x 2-1/4" x 8'	H	72
MH26608 (1556039)	Lattice	1/4" x 1-5/8" x 8'	H	72

Stock Code	Profile Type	Dimensions	Species	Page
MH26612 (1556041)	Lattice	1/4" x 1-5/8" x 12'	H	72
MH26708 (1556042)	Lattice	1/4" x 1-3/8" x 8'	H	72
MH26808 (1556045)	Lattice	1/4" x 1-1/8" x 8'	H	72
MH26810 (1556046)	Lattice	1/4" x 1-1/8" x 10'	H	72
MH26812 (1610644)	Lattice	1/4" x 1-1/8" x 12'	H	72
MH270 (1556047)	Picture Mould	5/8" x 1-9/16" x RL	H	66
MH29208 (1556050)	Wainscot Cap	7/16" x 1-1/8" x 8'	H	70
MH29210 (1556051)	Wainscot Cap	7/16" x 1-1/8" x 10'	H	70
MH297 (1556053)	Chair Rail	5/8" x 3" x RL	H	42
MH300007 (1328591)	Casing	1/2" x 1-1/2" x 7'	H	27
MH300008 (1556057)	Casing	1/2" x 1-1/2" x 8'	H	27
MH300010 (1556058)	Casing	1/2" x 1-1/2" x 10'	H	27
MH300012 (1556059)	Casing	1/2" x 1-1/2" x 12'	H	27
MH3002 (1556060)	Casing	1/2" x 2-3/16" x RL	H	27
MH300207 (1610661)	Casing	1/2" x 2-3/16" x 7'	H	27
MH300208 (1556062)	Casing	1/2" x 2-3/16" x 8'	H	27
MH300210 (1610663)	Casing	1/2" x 2-3/16" x 10'	H	27
MH300212 (1556064)	Casing	1/2" x 2-3/16" x 12'	H	27
MH300507 (1556065)	Casing	1/2" x 1-1/2" x 7'	H	29
MH300510 (1556067)	Casing	1/2" x 1-1/2" x 10'	H	29
MH301408 (1556070)	Casing	7/16" x 2-3/16" x 8'	H	27
MH3102 (1556073)	Baseboard	13/32" x 3-1/4" x RL	H	12
MH310208 (1556074)	Baseboard	13/32" x 3-1/4" x 8'	H	12
MH310210 (1556075)	Baseboard	13/32" x 3-1/4" x 10'	H	12
MH310212 (1556076)	Baseboard	13/32" x 3-1/4" x 12'	H	12
MH3112 (1556077)	Baseboard	3/8" x 3-1/4" x RL	H	20
MH320008 (1626335)	Quarter Round	1/2" x 1/2" x 8'	H	73
MH320208 (1556079)	Quarter Round	1/2" x 1/2" x 8'	H	73
MH320210 (1556080)	Quarter Round	1/2" x 1/2" x 10'	H	73
MH320608 (1556081)	Quarter Round	11/16" x 11/16" x 8'	H	73
MH320610 (1556082)	Quarter Round	11/16" x 11/16" x 10'	H	73
MH320612 (1610687)	Quarter Round	11/16" x 11/16" x 12'	H	73
MH3211 (1002120)	Casing	5/8" x 2-1/4" x RL	H	30
MH321208 (1556086)	Half Round	3/8" x 3/4" x 8'	H	71
MH3226 (1328607)	Full Round	1-5/16" x 1-5/16" x RL	H	71
MH322608 (1556091)	Full Round	1-5/16" x 1-5/16" x 8'	H	71
MH322610 (1556092)	Full Round	1-5/16" x 1-5/16" x 10'	H	71
MH322612 (1556093)	Full Round	1-5/16" x 1-5/16" x 12'	H	71
MH3226DS (1005892)	Full Round	1-5/16" x 1-5/16" x RL	H	71
MH3228 (1328609)	Full Round	1-1/2" x 1-1/2" x RL	H	71
MH322808 (1610700)	Full Round	1-1/2" x 1-1/2" x 8'	H	71
MH324208 (1556096)	Crown	1/2" x 11/16" x 8'	H	45
MH324210 (1556097)	Crown	1/2" x 11/16" x 10'	H	45
MH324408 (1610704)	Crown	9/16" x 1-1/4" x 8'	H	45
MH324410 (1556098)	Crown	9/16" x 1-1/4" x 10'	H	45
MH324412 (1556099)	Crown	9/16" x 1-1/4" x 12'	H	45
MH324812 (1556100)	Crown	1-3/16" x 2-1/4" x 12'	H	45
MH326008 (1556101)	Cove	1/2" x 1/2" x 8'	H	44
MH326408 (1556103)	Cove	11/16" x 11/16" x 8'	H	44
MH326410 (1556104)	Cove	11/16" x 11/16" x 10'	H	44
MH326412 (1610715)	Cove	11/16" x 11/16" x 12'	H	44
MH327408 (1556107)	Screen Mould	1/4" x 3/4" x 8'	H	72
MH327410 (1556108)	Screen Mould	1/4" x 3/4" x 10'	H	72
MH328008 (1328619)	Corner Guard	1-1/16" x 1-1/16" x 8'	H	43

# INDEX

Stock Code	Profile Type	Dimensions	Species	Page
MH328010 (1556110)	Corner Guard	1-1/16" x 1-1/16" x 10'	H	43
MH328208 (1328620)	Corner Guard	11/16" x 11/16" x 8'	H	43
MH328210 (1556112)	Corner Guard	11/16" x 11/16" x 10'	H	43
MH3288 (1328622)	Baseboard Shoe	7/16" x 11/16" x RL	H	72
MH328808 (1556114)	Baseboard Shoe	7/16" x 11/16" x 8'	H	72
MH328810 (1556115)	Baseboard Shoe	7/16" x 11/16" x 10'	H	72
MH328812 (1556116)	Baseboard Shoe	7/16" x 11/16" x 12'	H	72
MH33408 (1556117)	Cove	1-1/16" x 1-1/16" x 8'	H	44
MH33410 (1556118)	Cove	1-1/16" x 1-1/16" x 10'	H	44
MH33412 (1556119)	Cove	1-1/16" x 1-1/16" x 12'	H	44
MH342207 (1610731)	Door Stop	3/8" x 1-3/16" x 7'	H	56
MH3428 (1626361)	Square	1/2" x 3/4" x RL	H	68
MH342808 (1556122)	Square	1/2" x 3/4" x 8'	H	68
MH342810 (1556123)	Square	1/2" x 3/4" x 10'	H	68
MH3507 (1341911)	Hand Rail	1-1/4" x 2-1/4" x 8'	H	62
MH350708 (1556128)	Hand Rail	1-1/4" x 2-1/4" x 12'	H	62
MH350712 (1556129)	Hand Rail	1-1/4" x 2-1/4" x 12'	H	62
MH3507DS (1008100)	Hand Rail	1-1/4" x 2-1/4" x RL	H	62
MH351608 (1556131)	Square	3/4" x 3/4" x 8'	H	68
MH351610 (1556132)	Square	3/4" x 3/4" x 10'	H	68
MH351708 (1556133)	Square	1-1/16" x 1-1/16" x 8'	H	68
MH3520 (1610751)	Square	11/16" x 11/16" x RL	H	68
MH352007 (1610752)	Square	11/16" x 11/16" x 7'	H	68
MH356 (1556134)	Casing	5/8" x 2-1/4" x RL	H	29
MH35607 (1556135)	Casing	5/8" x 2-1/4" x 7'	H	29
MH35608 (1556136)	Casing	5/8" x 2-1/4" x 8'	H	29
MH35610 (1556137)	Casing	5/8" x 2-1/4" x 10'	H	29
MH35612 (1556138)	Casing	5/8" x 2-1/4" x 12'	H	29
MH410U (1556140)	Casing	11/16" x 2-1/4" x RL	H	30
MH410U07 (1556141)	Casing	11/16" x 2-1/4" x 7'	H	30
MH411U (1626369)	Casing	11/16" x 3" x RL	H	32
MH411U08 (1009060)	Casing	11/16" x 3" x 8'	H	32
MH412U (1556144)	Baseboard	9/16" x 4-1/4" x RL	H	16
MH4443D (1556147)	Casing	9/16" x 3-1/8" x RL	H	31
MH4443D08 (1556148)	Casing	9/16" x 3-1/8" x 8'	H	31
MH4443D12 (1556150)	Casing	9/16" x 3-1/8" x 12'	H	31
MH469 (1006585)	Baseboard	1/2" x 3-1/2" x RL	H	20
MH472 (1556152)	Casing	5/8" x 2-1/2" x RL	H	35
MH47207 (1610775)	Casing	5/8" x 2-1/2" x 7'	H	35
MH47207-VEN (1610776)	Casing	11/16" x 2-1/2" x 7'	H	35
MH493 (1007076)	Casing	1/2" x 2-1/4" x RL	H	35
MH49307 (1008483)	Casing	1/2" x 2-1/4" x 7'	H	35
MH495 (1556156)	Casing	5/8" x 3-1/2" x RL	H	37
MH49507 (1556157)	Casing	5/8" x 3-1/2" x 7'	H	37
MH49507-VEN (1005003)	Casing	11/16" x 3-1/2" x 7'	H	37
MH49508 (1556158)	Casing	5/8" x 3-1/2" x 8'	H	37
MH49508-VEN (1610785)	Casing	11/16" x 3-1/2" x 8'	H	37
MH5000 (1556159)	Architrave	1-3/16" x 3-3/4" x RL	H	6
MH5020 (1556160)	Architrave	1-3/16" x 5-1/4" x RL	H	8
MH50708 (1610792)	Brick Mould	1-3/16" x 1-1/2" x 8'	H	26
MH50712 (1556163)	Brick Mould	1-3/16" x 1-1/2" x 12'	H	26
MH535 (1556164)	Casing	11/16" x 3-1/2" x RL	H	34
MH53508 (1556165)	Casing	11/16" x 3-1/2" x 8'	H	34
MH545 (1556166)	Baseboard	9/16" x 5" x RL	H	19

Stock Code	Profile Type	Dimensions	Species	Page
MH569 (1008980)	Baseboard	1/2" x 4-1/2" x RL	H	21
MH59307 (1556167)	Door Stop	1/2" x 1-11/16" x 80"	H	57
MH618 (1556168)	Baseboard	1/2" x 5-1/4" x RL	H	15
MH621 (1009329)	Baseboard	1/2" x 4-1/4" x RL	H	14
MH623 (1626374)	Baseboard	7/16" x 3-1/4" x RL	H	14
MH62308 (1556170)	Baseboard	7/16" x 3-1/4" x 8'	H	14
MH62310 (1556171)	Baseboard	7/16" x 3-1/4" x 10'	H	14
MH62312 (1556172)	Baseboard	7/16" x 3-1/4" x 12'	H	14
MH625 (1556173)	Baseboard	7/16" x 2-1/4" x RL	H	14
MH62508 (1556174)	Baseboard	7/16" x 2-1/4" x 8'	H	14
MH62510 (1556175)	Baseboard	7/16" x 2-1/4" x 10'	H	14
MH62512 (1556176)	Baseboard	7/16" x 2-1/4" x 12'	H	14
MH669 (1009273)	Baseboard	7/16" x 5-1/2" x RL	H	21
MH702 (1556181)	Wainscot Cap	5/8" x 1-3/8" x RL	H	70
MH703 (1002359)	Panel Mould	1/2" x 3/4" x RL	H	66
MH704 (1008058)	Glass Bead	5/8" x 5/8" x RL	H	61
MH706 (1556184)	Wainscot Cap	3/4" x 2" x RL	H	70
MH750 (1004178)	Baseboard	5/8" x 5-1/4" x RL	H	23
MH751 (1003931)	Baseboard	5/8" x 7-1/4" x RL	H	23
MH754 (1011154)	Casing	11/16" x 3-1/4" x RL	H	40
MH86508 (1588566)	Door Stop	7/16" x 1-1/2" x 8'	H	56
MH86510 (1556189)	Door Stop	7/16" x 1-1/2" x 10'	H	56
MH86607 (1556190)	Door Stop	7/16" x 1-5/16" x 7'	H	56
MH86608 (1556191)	Door Stop	7/16" x 1-5/16" x 8'	H	56
MH86610 (1556192)	Door Stop	7/16" x 1-5/16" x 10'	H	56
MH86612 (1610835)	Door Stop	7/16" x 1-5/16" x 12'	H	56
MH86908 (1610836)	Door Stop	7/16" x 1-1/16" x 8'	H	56
MH86910 (1610837)	Door Stop	7/16" x 1-1/16" x 10'	H	56
MH936 (1006795)	Door Stop	3/8" x 1-3/8" x RL	H	56
MH9531 (1002762)	Sash Bead	7/16" x 1-1/4" x RL	H	61
MH9532 (1008270)	Sash Bead	7/16" x 1-1/4" x RL	H	61
MH995 (1556198)	Chamfer Strip	3/4" x 3/4" x RL	H	71
MHAST1315 (1002891)	Astragal	1-1/4" x 2" x 7'	H	9
MHAST18 (1003139)	Astragal	1-3/16" x 2" x 8'	H	10
MHAST38 (1008937)	Astragal	1-3/8" x 3" x 8'	H	10
MHAST47 (1002639)	Astragal	1-9/16" x 3" x 7'	H	10
MHAST48 (1004654)	Astragal	1-9/16" x 3" x 8'	H	10
MHJ413 (1610858)	Jamb	11/16" x 4-13/16" x 81-5/8"	H	63
MHJ413C (1009731)	Jamb	1-3/16" x 4-13/16" x 97-5/8"	H	63
MHJ413C80 (1002202)	Jamb	1-3/16" x 4-13/16" x 97-5/8"	H	63
MHJ413FSA (1556205)	Jamb	1-1/16" x 4-13/16" x 81-5/8"	H	63
MHJ415C70 (1006697)	Jamb	1-3/16" x 4-5/16" x 85-5/8"	H	63
MHJ49 (1556208)	Jamb	11/16" x 4-9/16" x 81-5/8"	H	63
MHJ49C80 (1005860)	Jamb	1-3/16" x 4-9/16" x 97-5/8"	H	63
MHJ49D3 (1008920)	Jamb	1-3/16" x 4-9/16" x 81-5/8"	H	63
MHJ49F (1556215)	Jamb	11/16" x 4-9/16" x 82-1/4"	H	63
MHJ49F-S09 (1610887)	Jamb	11/16" x 4-9/16" x 81-11/16"	H	63
MHJ49FSA (1052660)	Jamb	1-3/16" x 4-9/16" x 81-5/8"	H	63
MHJ49FX (1328645)	Jamb	11/16" x 4-9/16" x 83-1/2"	H	63
MHJ49K (1677202)	Jamb	1-3/16" x 4-9/16" x 83-1/2"	H	63
MHJ49KL-S01 (1677153)	Jamb	1-3/16" x 4-9/16" x 82"	H	63
MHJ51K (1005130)	Jamb	1-3/16" x 5-1/16" x 83-1/2"	H	64
MHJ613C (1668205)	Jamb	1-3/16" x 6-13/16" x 81-5/8"	H	64
MHJ613K (1002897)	Jamb	1-3/16" x 6-13/16" x 83-1/2"	H	64





# INDEX

Stock Code	Profile Type	Dimensions	Species	Page
MPJ49D (1556351)	Jamb	1-7/32" x 4-9/16" x 81-5/8"	PFJ	64
MPJ49D80 (1328841)	Jamb	1-7/32" x 4-9/16" x 97-5/8"	PFJ	64
MPJ49DCC (1328842)	Jamb	1-3/16" x 4-9/16" x 81-5/8"	PFJ	64
MPJ49DCC80 (1678943)	Jamb	1-3/16" x 4-9/16" x 97-5/8"	PFJ	64
MPJ49F (1556358)	Jamb	11/16" x 4-9/16" x 82-1/4"	PFJ	64
MPJ49F-S09 (1556360)	Jamb	11/16" x 4-9/16" x 81-11/16"	PFJ	64
MPJ49FX (1556361)	Jamb	11/16" x 4-9/16" x 83-1/2"	PFJ	64
MPJ49K (1556362)	Jamb	1-7/32" x 4-9/16" x 83-1/2"	PFJ	64
MPJ49K-S01 (1556364)	Jamb	1-7/32" x 4-9/16" x 82"	PFJ	64
MPJ49K-S17 (1556366)	Jamb	1-7/32" x 4-9/16" x 81-3/4"	PFJ	64
MPJ51C (1556368)	Jamb	1-7/32" x 5-1/4" x 81-5/8"	PFJ	64
MPJ51K (1611232)	Jamb	1-7/32" x 5-1/4" x 83-1/2"	PFJ	64
MPJ613C (1556370)	Jamb	1-7/32" x 6-13/16" x 81-5/8"	PFJ	64
MPJ613K (1556371)	Jamb	1-7/32" x 6-13/16" x 83-1/2"	PFJ	64
MPJ613K-S01 (1678901)	Jamb	1-7/32" x 6-13/16" x 82"	PFJ	64
MPJ613KS70 (1556372)	Jamb	1-7/32" x 6-13/16" x 86-3/4"	PFJ	64
MPJ69C (1314632)	Jamb	1-7/32" x 6-9/16" x 81-5/8"	PFJ	64
MPJ69C80 (1472593)	Jamb	1-7/32" x 6-9/16" x 97-5/8"	PFJ	64
MPJ69F (1556377)	Jamb	11/16" x 6-9/16" x 82-1/4"	PFJ	64
MPJ69F-S09 (1556379)	Jamb	11/16" x 6-9/16" x 81-11/16"	PFJ	64
MPJ69FX (1008055)	Jamb	11/16" x 6-9/16" x 83-1/2"	PFJ	64
MPJ69K (1611249)	Jamb	1-7/32" x 6-9/16" x 83-1/2"	PFJ	64
MPJ69K-S01 (1556390)	Jamb	1-7/32" x 6-9/16" x 82"	PFJ	64
MPJ69K-S14 (1556391)	Jamb	1-7/32" x 6-9/16" x 81-7/8"	PFJ	64
MPJ69K-S17 (1556392)	Jamb	1-7/32" x 6-9/16" x 81-3/4"	PFJ	64
MPJ69K80 (1556383)	Jamb	1-7/32" x 6-9/16" x 100"	PFJ	64
MPJ71C (1556394)	Jamb	1-7/32" x 7-1/4" x 81-5/8"	PFJ	64
MPJ71C70 (1556395)	Jamb	1-7/32" x 7-1/4" x 85-5/8"	PFJ	64
MPJ71C80 (1611266)	Jamb	1-7/32" x 7-1/4" x 97-5/8"	PFJ	64
MPJ71K (1556397)	Jamb	1-7/32" x 7-1/4" x 83-1/2"	PFJ	64
MPJ71K-S01 (1556400)	Jamb	1-7/32" x 7-1/4" x 82"	PFJ	64
MPJ71K-S17 (1556401)	Jamb	1-7/32" x 7-1/4" x 81-3/4"	PFJ	64
MPJ71K80 (1556398)	Jamb	1-7/32" x 7-1/4" x 100"	PFJ	64
MPJ71KS70 (1611275)	Jamb	1-7/32" x 7-1/4" x 86-3/4"	PFJ	64
MPJ878K80 (1556403)	Jamb	1-7/32" x 8-7/8" x 8'	PFJ	64
MPJ878KS70 (1611278)	Jamb	1-7/32" x 8-7/8" x 86-3/4"	PFJ	64
MRO3002 (1328875)	Casing	7/16" x 2-1/4" x RL	O	27
MRO3206 (1626639)	Quarter Round	3/4" x 3/4" x RL	O	73
MRO356 (1006931)	Casing	7/16" x 2-1/16" x RL	O	29
MRO623 (1556440)	Baseboard	3/8" x 3-1/4" x RL	O	14
MTEK003 (1556485)	Casing	11/16" x 3-1/4" x 16'	COM	34
MTEK047 (1556486)	Crown	5/8" x 4-1/4" x 16'	COM	46
MTEK051 (1556487)	Crown	5/8" x 3-1/4" x 16'	COM	47
MTEK1/04 (1611361)	Flat Stock	1/2" x 3-1/2" x 16'	COM	60
MTEK1/06 (1588767)	Flat Stock	1/2" x 5-1/2" x 16'	COM	60
MTEK102 (1556488)	Flat Stock	23/32" x 1-1/2" x 16'	COM	60
MTEK103 (1556489)	Flat Stock	11/16" x 2-1/2" x 16'	COM	60
MTEK104 (1329017)	Flat Stock	11/16" x 3-1/2" x 16'	COM	60
MTEK105 (1556491)	Flat Stock	11/16" x 4-9/16" x 16'	COM	60
MTEK106 (1556492)	Flat Stock	11/16" x 5-1/2" x 16'	COM	60
MTEK107 (1556493)	Flat Stock	11/16" x 6-9/16" x 16'	COM	60
MTEK108 (1556494)	Flat Stock	11/16" x 7-1/4" x 16'	COM	60
MTEK110 (1556495)	Flat Stock	11/16" x 9-1/4" x 16'	COM	60
MTEK356 (1556496)	Casing	9/16" x 2-1/4" x 16'	COM	29

Stock Code	Profile Type	Dimensions	Species	Page
MTEK35607 (1556497)	Casing	9/16" x 2-1/4" x 7'	COM	29
MTEK473 (1588769)	Casing	9/16" x 2-1/4" x 16'	COM	36
MTEK495 (1556498)	Casing	11/16" x 3-1/2" x 16'	COM	37
MTEK5000 (1556499)	Architrave	1-3/16" x 3-3/4" x 16'	COM	6
MTEK5020 (1611393)	Architrave	1-3/16" x 5-1/4" x 16'	COM	8
MTEK544 (1007214)	Flat Stock	1" x 3-1/2" x 16'	COM	60
MTEK546 (1588772)	Flat Stock	1" x 5-1/2" x 16'	COM	60
MTEK618 (1556501)	Baseboard	1/2" x 5-1/4" x 16'	COM	15
MTEK623 (1011022)	Baseboard	1/2" x 3-1/4" x 16'	COM	14
MTEK62307 (1006843)	Baseboard	1/2" x 3-1/4" x 7'	COM	14
MTEK625 (1556503)	Baseboard	1/2" x 2-1/4" x 16'	COM	14
MTEK9532 (1556504)	Sash Bead	7/16" x 1-1/4" x 12'	COM	61
MTEKJ413C (1009762)	Jamb	1-7/32" x 4-13/16" x 81-5/8"	COM	64
MTEKJ49D (1556509)	Jamb	1-7/32" x 4-9/16" x 81-5/8"	COM	64
MTEKJ613K (1011084)	Jamb	1-7/32" x 6-13/16" x 83-1/2"	COM	64
MTEKJ71K (1556513)	Jamb	1-7/32" x 7-1/4" x 83-1/2"	COM	64
MTEKOGCHAIR (1611427)	Door Stop	7/16" x 3-1/4" x 16'	COM	57
MXFMG104FLOOR (1003124)	T & G Panel	3/4" x 3-3/8" x RL	FIR	69
MXFMG104TG (1611449)	T & G Panel	9/16" x 3-5/16" x RL	FIR	69
MXFMG106TG (1611450)	T & G Panel	9/16" x 5-3/8" x RL	FIR	69
MXFVG104TG (1626775)	T & G Panel	9/16" x 3-5/16" x RL	FIR	69
MXFVG106TG (1556523)	T & G Panel	9/16" x 5-3/8" x RL	FIR	69
MXHVG104TG (1011474)	T & G Panel	9/16" x 3-5/16" x RL	H	69
MXHVG106TG (1009976)	T & G Panel	9/16" x 5-3/8" x RL	H	69
MXPEX104TG (1556526)	T & G Panel	9/16" x 3-5/16" x RL	PFJ	69
MXPEX106TG (1556527)	T & G Panel	9/16" x 5-3/8" x RL	PFJ	69



## EXPLORE OTHER PRODUCTS FROM METRIE®

In addition to our vast profile assortment, we offer unique product solutions that make it easy to select and install millwork.



Coordinated Collections of interior moulding that are professionally designed to ensure harmonious proportions, timeless beauty and perfect scale.



Curated moulding & interior door combinations that complement today's top décor trends.



Pre-painted & ready to install moulding solution that allows you to finish before you start.



# METRIE IS NORTH AMERICA'S LEADING MANUFACTURER AND DISTRIBUTOR OF INTERIOR FINISHINGS.

Our industry position has allowed us the resources, strength and leadership to create solutions that make it easier for consumers and design professionals to select, purchase and design with interior mouldings.

Metrie products distributed by:



2200 - 140TH AVENUE E, SUITE 600  
SUMNER, WA 98390  
T: 253.470.5050 F: 253.470.5051

© 2018 Metrie® MET-480-SEA\_0618 Printed in USA

METRIE.COM