

# ADVANTAGE<sup>®</sup>

## MORTISE LOCKS



**HURRICANE**  
APPROVED HARDWARE

**MIAMI-DADE COUNTY**  
APPROVED

Notice of Acceptance  
(NOA) No. 15-0629.03  
Air Infiltration rating +/- 90 PSF  
Water Resistance rating +/- 90 PSF  
Florida Building Code: 20485



Always Striving.  
[philhardware.com](http://philhardware.com)



# lock design



# lock design

LIFETIME Warranty  
**BHMA** CERTIFIED **GRADE 1** LISTED  

LIFETIME Warranty

## certification / compliance

- Locks comply with UL 10B, "Fire Tests of Door Assemblies, and "UL 10C," Positive Pressure Fire Tests of Door Assemblies" and the Uni form Building Code Standard UBC 7-2, "Fire Test of Door Assemblies" (1997).
- BHMA certified, Meets ANSI/BHMA A156.13-2005, Series 1000, Grade 1.
- Lever design complies with California State Reference Code: levers return to within 1/2" (13mm) of door face.
- Comply with ANSI A117.1 for Barrier Free Accessibility.
- **Hurricane Approved Hardware rated +/- 90 PSF by Miami-Dade County NOA #15-0629.03 Florida Building Code: 20485**



## deliberate design



- Escutcheon Lever and Sectional Lever Type available.
- Outside trims are concealed screw to prevent vandalism.
- Featured heavy-duty spring cartridge on both exterior and interior to prevents lever sag.
- Posts fit through holes in the lock case and are secured by square spindle.
- 3 Lever designs are available as shown above.

## easy for handing

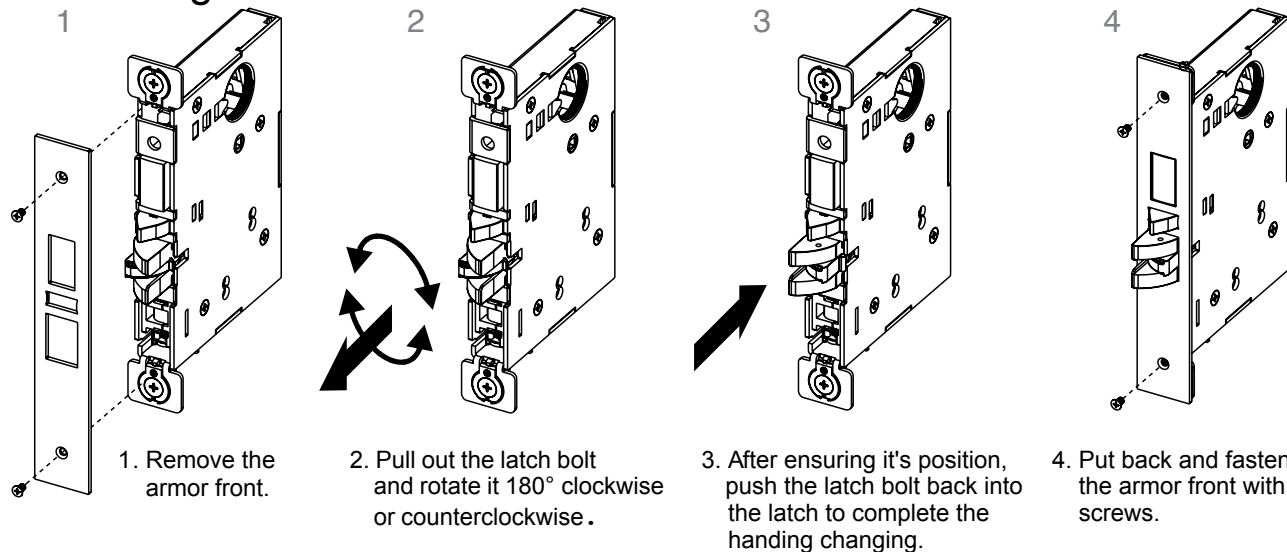

## features

### door thickness

- 1-3/4" to 2" standard, 2-1/4" special order

### spacing

- Center to center, hub to cylinder: 3-7/8" (98mm)
- Center to center, hub to turnpiece 2-11/16" (68 mm)

### handing

- Field reversible (Standard shipped in Right hand)

### mortise case

- Size – 6-1/32" x 4-1/32" x 57/64"
- Heavy Gauge cold rolled steel, zinc dichromate plated for corrosion resistance
- Faceplate Adjustable from flat to standard 1/8" in 2" beveled door edges

### backset

- 2-3/4" only

### faceplate

- 8" x 1-1/4". Stainless steel

### latchbolt

- 3/4" throw anti-friction, stainless steel. Field reversible

### deadbolt (on applicable functions)

- 1" throw, stainless steel

### guard bolt (on applicable functions)

- Non-handed, stainless steel

### toggle (on applicable functions):

- Rocker Type, stainless steel

### strike

- 4-7/8" x 1-1/4" x 3/32" (ASA) Curved Lip, Stainless steel

### mortise cylinder

- 6-pins Schlage keyway with 2 keys
- Schlage L Cam
- Size 1-1/4" Standard for Escutcheon Trim, door fitting 1-3/4"
- Size 1-1/8" Standard for Sectional Trim, door fitting 1-3/4"

### keying

- Can be MK, CMK, GMK

### finish

- 626 (US26D), 613 (US10B), 625 (US26), Special Order for 630 (US32D)

### outside trim

- Standard commercial style lever, forged Brass
- Trim available in both Escutcheon Plate (ME) and Sectional Rosette (MS) format, forged Brass
- Concealed screws on Sectional Trim

720ME-SD  
San Diego (SD) Lever



720MS-BN  
Bozeman (BN) Lever





## new case

Distance from cylinder hole center line to lever hub center line is 3-7/8" (98mm)

### armor front

- 8" x 1-1/4" Outside front plate, stainless steel
- Adjustable for door bevels from flat to 1/8" in 2" deadbolt

- 1" throw, stainless steel with heavy gauge hardened steel insert

### latchbolt

- 3/4" throw, 3 piece stainless steel antifriction latch bolt, reversible for right hand or left hand door

### auxiliary deadlatch

- Non-handed stainless steel

### ul listed

- For application on labeled fire doors

### backset

- 2-3/4" only

### case

- Wrought steel, zinc dichromated

### toggle

- Rocker type, stainless steel

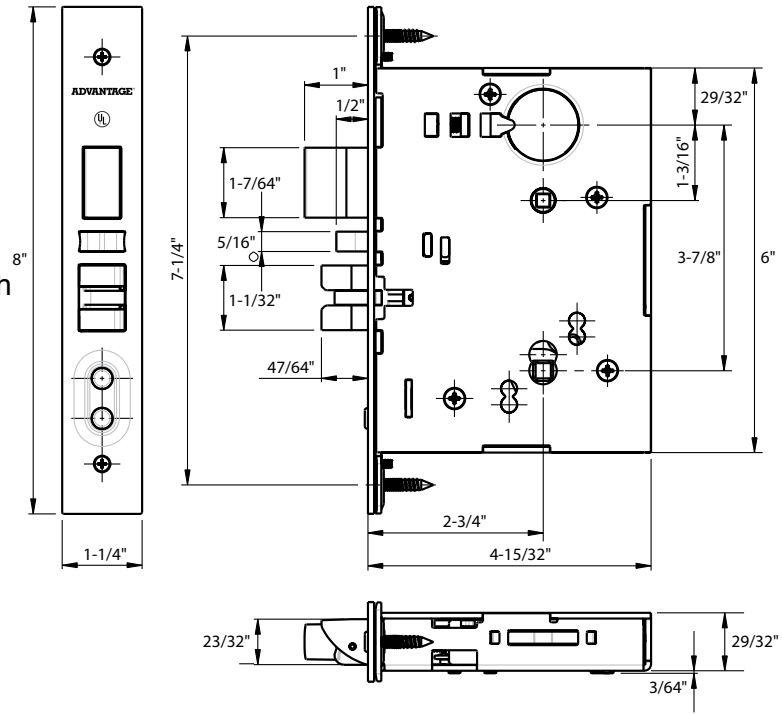

## mortise cylinder and door fitting application:

Fitting Door Thickness	Mortise Lock		Mortise Cylinder - Cylinder Collar Fitting		
	ME Single	ME Double	1-1/4"	1-3/8"	1-9/16"
1-3/4"	ME Single	OK	OK	OK	CR2-3
	ME Double	OK	OK	CR2-3	CR2-4
2"	ME Single	OK	OK	OK	OK
	ME Double	OK	OK	OK	CR2-3
1-3/4"	MS Single	OK	C13	C16	C16
	MS Double	OK	C16	C20	C20
2"	MS Single	OK	C13	C16	C16
	MS Double	OK	C16	C20	C20

• 2-1/4" Door Thick – Please call to check (Lock body should use longer screw post x 2 when door thickness is 2-1/4")

### Mortise Cylinder Length

1-1/4" (31.7mm) – Available with KW1, SC4, BEST SFIC 6pins Housing

1-3/8" (34.9mm) – Available with KW1, SC4, BEST SFIC 7pins Housing

1-9/16" (39.6mm) – Available with Schlage FSIC Housing

\* All Mortise Cylinder are equipped with Schlage style L cam

### Cylinder Collar Sizes

For ME: CR2 (2 side reversible)

Front: CR2-3 Side for 1/8" (3mm) extended height

Back: CR2-4 Side for 5/32" (3.8mm) extended height

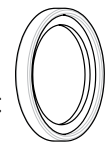

For MS: C10 – 25/64" (10.0mm) Standard

C13 – 1/2" (13.0mm)

C16 – 5/8" (16.2mm)

C20 – 13/16" (20.5mm)



### Mortise Cylinder



### BEST SFIC Mortise Housing



### Schlage FSIC Mortise Housing



## ME - escutcheon trim lever style

### Charlotte (CT)

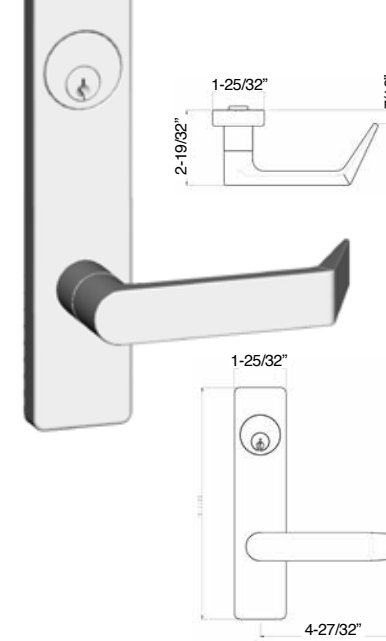

### San Diego (SD)

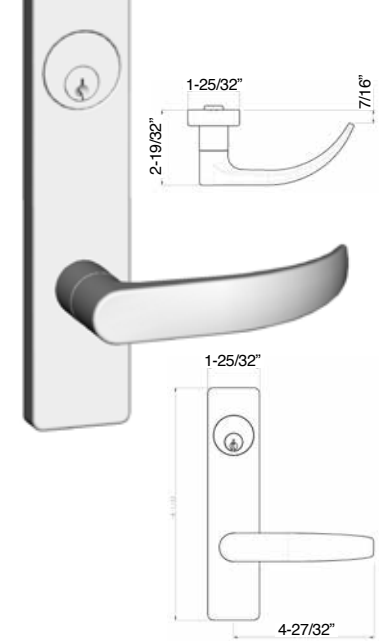

### Bozeman (BN)

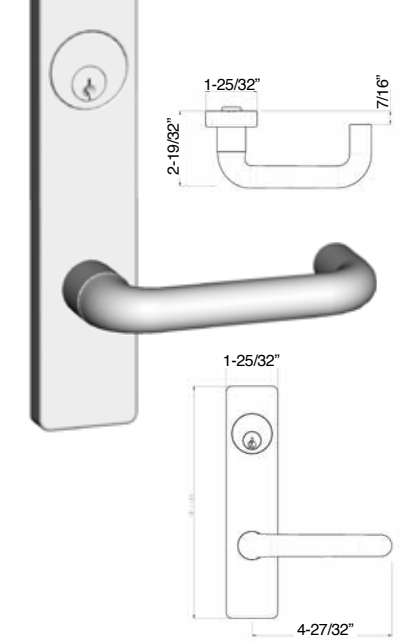

## MS - sectional trim lever style

### Charlotte (CT)

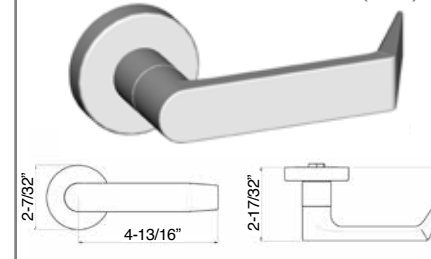

### San Diego (SD)

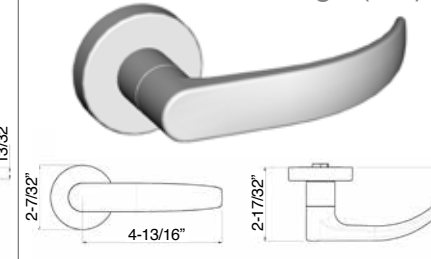

### Bozeman (BN)

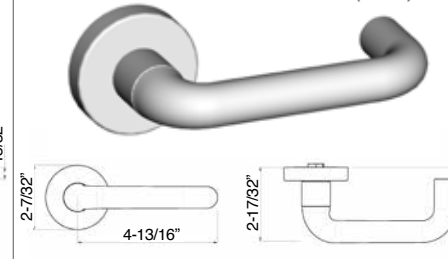

## Special order lever/knob

### Madison (MD)

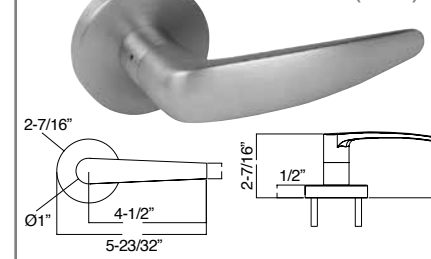

### Boren (BO)

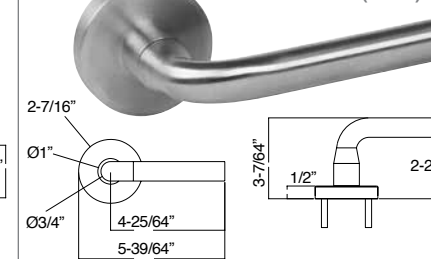

### Bala (BA)

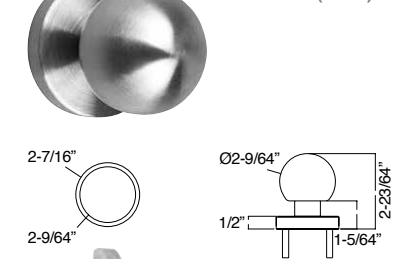

Exterior Indicator for Privacy (F02, F19, F22)



Interior ADA Thumbpiece







## single cylinder without deadbolt

**704M Office/Entrance (w/toggle) ANSI F04**

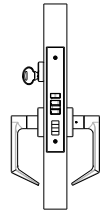

- Latch bolt operated by lever from either side except when outside lever is made inoperative by the toggle.
- When outside lever is locked, latch bolt is retracted by key from outside or by operating inside lever.
- Auxiliary dead latch.

**705M Classroom ANSI F05**

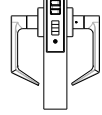

- Latch bolt operated by lever from either side except when outside lever is locked from outside by key.
- When outside lever is locked, latch bolt is retracted by key or by operating inside lever.
- Auxiliary dead latch.

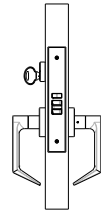

**707M Storeroom ANSI F07**

- Latch bolt operated by key from outside or by operating inside lever. Outside lever is always inoperative.
- Auxiliary dead latch.

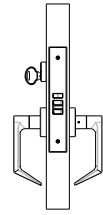

## double cylinder without deadbolt

**709M Apartment, Exit ANSI F09**

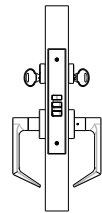

- Latch bolt operated by lever from either side, except when outside lever is locked by key from inside.
- When outside lever is locked, latch bolt is retracted by key from outside or by operating inside lever.
- Auxiliary dead latch.

**732M Intruder Latch Bolt ANSI F32**

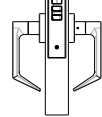

- Latch bolt operated by lever from either side except when outside lever is locked from inside or outside by key.
- When outside lever is locked, latch bolt is retracted by key from inside or outside or by operating inside lever.
- Auxiliary dead latch.

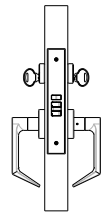

**730M Institution ANSI F30**

- Latch bolt operated by key from either side. Both levers always inoperative.
- Auxiliary dead latch

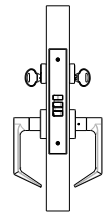

## single cylinder with deadbolt

**708M Front/Corridor Door (w/toggle) ANSI F08**

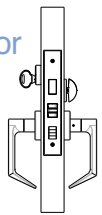

- Latch bolt is operated by lever from either side, except when outside lever is made inoperative by the toggle.
- Dead bolt is operated by turn inside.
- Key outside operates both bolts.

**713M Corridor/Dormitory ANSI F13**

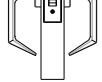

- Latch bolt operated by lever from either side. Dead bolt projected by key from outside and turn from inside.
- Operating inside lever retracts both bolts and unlocks outside.



**720M Entrance (w/toggle) ANSI F20**

- Latch bolt operated by lever from either side, except when outside lever is made inoperative by the toggle.
- Dead bolt operated by key outside or turn inside. Key outside operates both bolts.
- Operating inside lever retracts both bolts and outside remains locked.
- Latch bolt is deadlocked when outside lever is made inoperative or when the dead bolt is projected.
- When dead bolt is retracted, lever is unlocked by the toggle.
- Auxiliary dead latch.

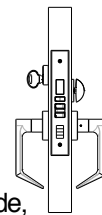

**721M Dormitory/Bedroom ANSI F21**

- Latch bolt operated by lever from either side.
- Dead bolt operated by key from outside and turn from inside.

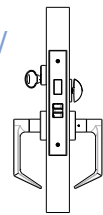

**765M Closet/Storeroom**

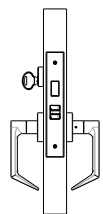

- Latch bolt retracted by lever from either side.
- Dead bolt operated by key outside.

**715M Hotel Guest ANSI F15**

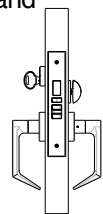

- Latch bolt is operated by key from outside or by operating inside lever. Outside lever is always inoperative.
- Dead bolt projected by turn from inside, operating inside lever retracts both bolts.
- Auxiliary dead latch.

## double cylinder with deadbolt

**711M Dormitory, Exit (w/toggle) ANSI F11**

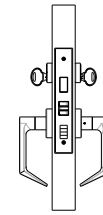

- Latch bolt operated by lever from either side except when outside lever is made inoperative by the toggle.
- Dead bolt projected by key from either side.
- Dead bolt retracted by key from outside.
- Both bolts retracted by inside lever and outside remain locked.

**714M Store Door ANSI F14**

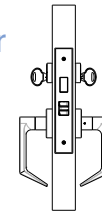

- Latch bolt operated by lever from either side.
- Dead bolt operated by key from either side.

**733M Intruder Dead Bolt ANSI F33**

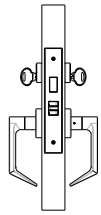

- Latch bolt operated by lever from either side except when outside lever is locked from inside or outside by key.
- Dead bolt retracted by key from inside or outside.
- Operating inside lever retracts both bolts and unlocks outside.

**734M Intruder Dead Bolt ANSI F34**

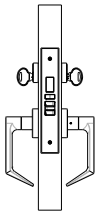

- Latch bolt operated by lever from either side except when outside lever is locked from inside or outside by key.
- Dead bolt retracted by key from inside or outside.
- Operating inside lever retracts both bolts and unlocks outside.
- Auxiliary dead latch.

## non-key

**701M Passage ANSI F01**

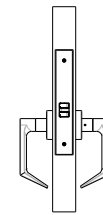

- Latch bolt operated by lever from either side at all times.

**702M Privacy ANSI F02**

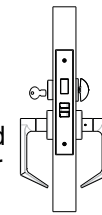

- Latch bolt operated by lever from either side. Dead bolt operated by turn from inside and by emergency release from outside.

**719M Privacy ANSI F19**

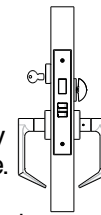

- Latch bolt operated by lever from either side.
- Dead bolt operated by turn from inside and emergency release from outside.
- Operating inside lever retracts both bolts.

**722M Privacy ANSI F22**

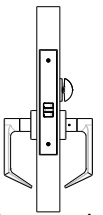

- Latch bolt operated by lever from either side except when outside lever is locked by inside turn or button.
- Operating inside lever, closing door or operating outside emergency release unlocks outside lever.

## no trim deadbolt

**716M Double Cylinder ANSI F16**

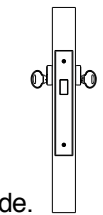

- Dead bolt operated by key from either side.

**717M Cylinder & Thumbturn ANSI F17**

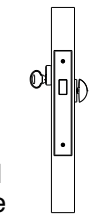

- Dead bolt operated by key from outside and by turn from inside.

**778M Single Dummy**

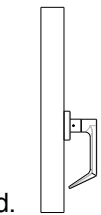

- Lever on one side is always rigid.

**776M Double Dummy**

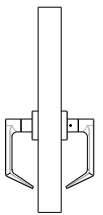

- Lever on both sides are always rigid.

## wood stand

**718M Single Cylinder ANSI F18**

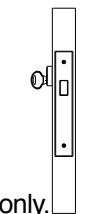

- Dead bolt operated by key from outside only.

**729M Classroom ANSI F29**

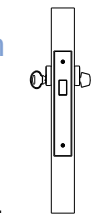

- Key from outside operates dead bolt.
- Turn from inside retracts but does not project dead bolt.

**Type #57 for MS**

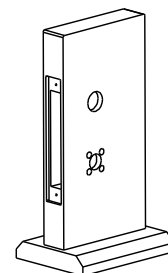

**Type #58 for ME**

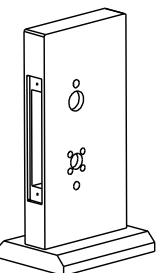

**DISTRIBUTION BY:**



## Philadelphia Hardware Group Inc.

**SAN DIEGO DISTRIBUTION CENTER**

(Home Office)  
6590 Top Gun Street  
San Diego, CA 92121  
Tel: (858) 642-0450  
Fax: (858) 642-0454  
Toll Free Tel: 1-800-545-2309  
Toll Free Fax: 1-800-828-0988  
[www.philihardware.com](http://www.philihardware.com)

**CHICAGO DISTRIBUTION CENTER**

3687 Darlene Court  
Aurora, IL 60504  
Toll Free Tel: 1-800-545-2309

**ATLANTA DISTRIBUTION CENTER**

2319 Defoor Hills Road N.W.  
Atlanta, GA 30318  
Toll Free Tel: 1-800-545-2309

**DALLAS DISTRIBUTION CENTER**

4653 Leston Avenue, Suite 703  
Dallas, TX 75247  
Toll Free Tel: 1-800-545-2309